

# 219s-10 Gradation Pouch



## Suggested yarn:

- Pierrot Yarns Cotton Neat S [100% cotton; 104 yds/95m per 1.41 oz./40g skein];
  - version A:
    - color #01 white, 1 skein [5g]
    - color #27 berry pink, 1 skein [30g]
    - color #29 rose pink, 1 skein [20g]
    - color #31 powder pink, 1 skein [20g]
  - version B:
    - color #01 white, 1 skein [5g]
    - color #85 navy blue, 1 skein [30g]
    - color #11 baby blue, 1 skein [20g]
    - color #84 ultramarine, 1 skein [20g]

## Tools/Notions:

- 3.0mm (approx. US C or D) crochet hook or size necessary to achieve gauge
- 1 white zipper per pouch (18cm/7.1")
- 1 piece of lining fabric per pouch (14cm/5.5" by 54cm/21.3")

## Finished measurements:

- height (including zipper) 12cm/4.7"
- width 19cm/7.5"

## Gauge (10cm/4" square):

- pattern stitch: 23.5 sts and 8.5 rounds
- sc (US): 23.5 sts and 25 rounds

*Gauge may vary according to individual crochet style. Change hook size if necessary to achieve gauge. Alternatively, rework pattern with your own gauge measurements.*

## Summary

✳️**Note:** Like all Japanese patterns, stitch counts given here for foundation chains do not include any chain sts needed for turning posts.

**Body of pouch:** Work magic ring to begin, then work bottom in sc in the round, increasing according to chart. Continue to sides, working pattern stitch and sc in the round per chart.

**Finishing:** Sew zipper to mouth of pouch. Cut lining fabric and finish edges as indicated. Insert lining into pouch, then whipstitch to wrong side of zipper.

## Abbreviations:

ch = chain    hdc2tog = work 2 half double crochet (US) sts together    m = magic ring/circle    rep = pattern repeat(s)    RS = right side    sc = single crochet (US)    WS = wrong side

# Body 3.0mm hook

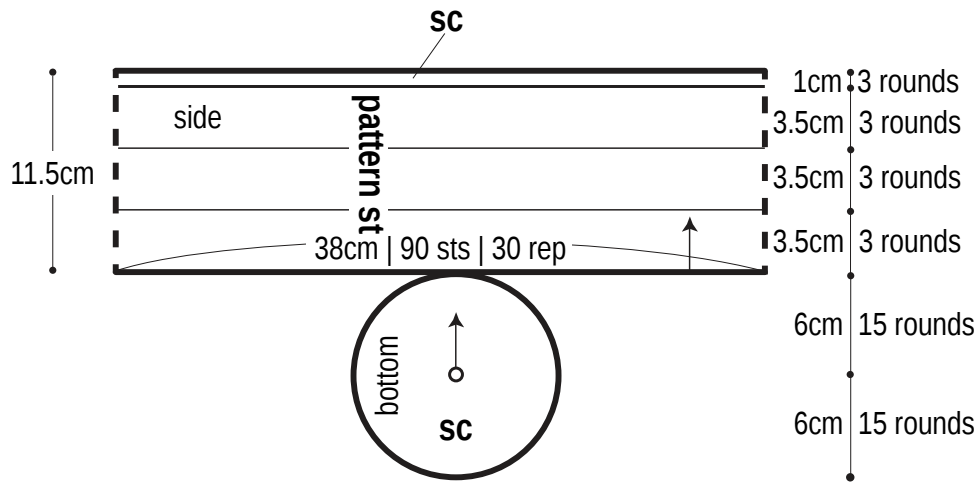

## Side

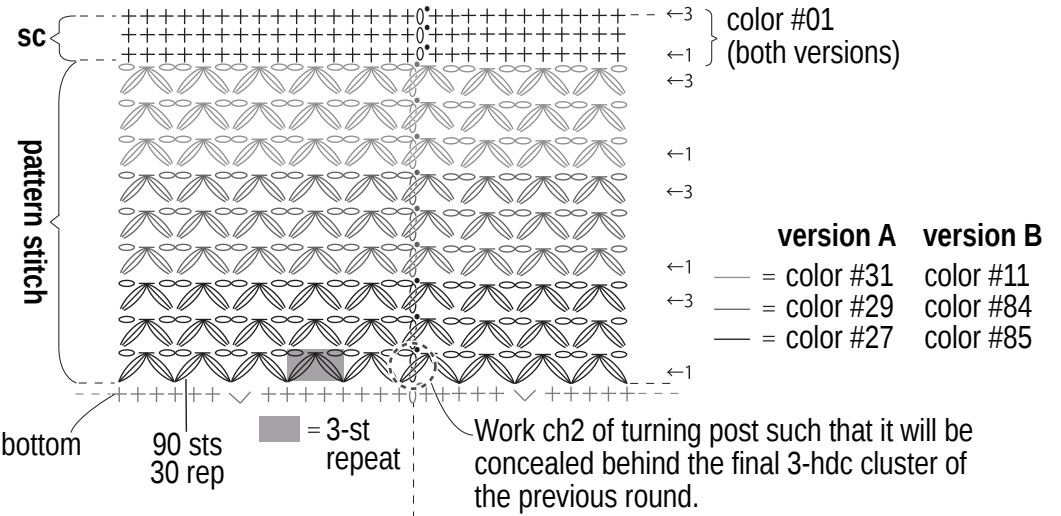

## Lining

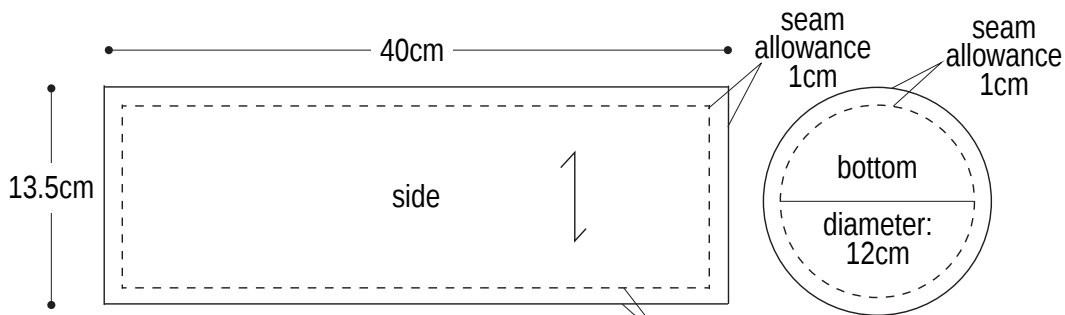

Use QR code on smartphone to view a video tutorial about how to work two 3-hdc clusters together.



## Bottom

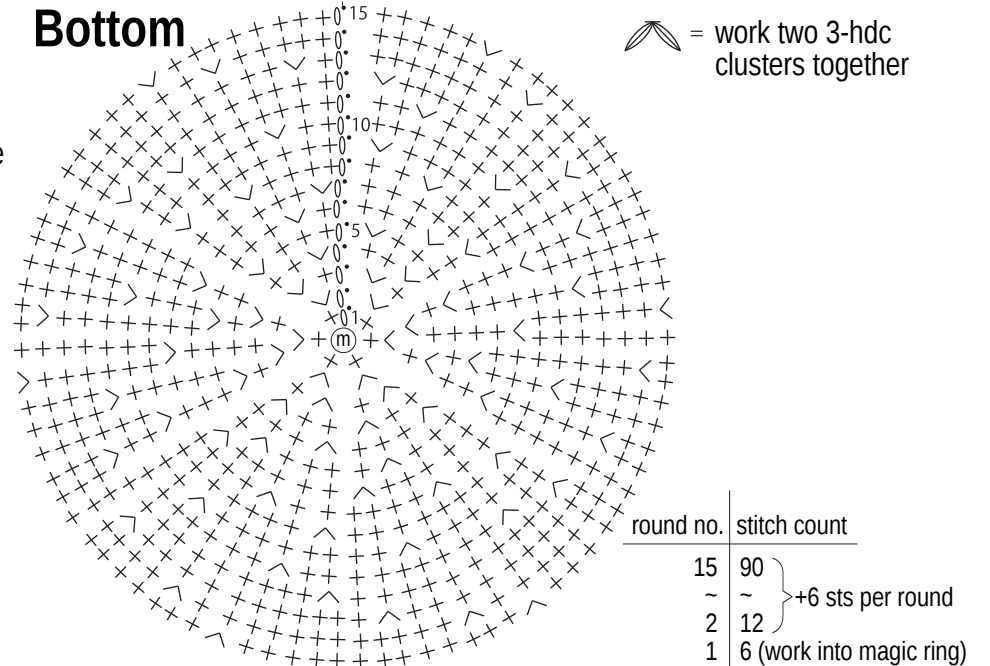

## Lining

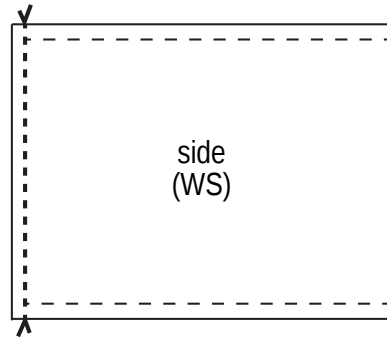

Fold side piece at center with right sides facing each other. Seam side.

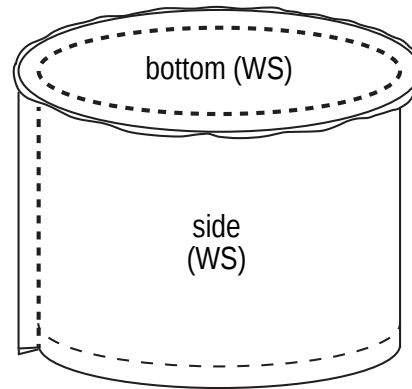

Seam sides to bottom with right sides facing each other.

## Finishing

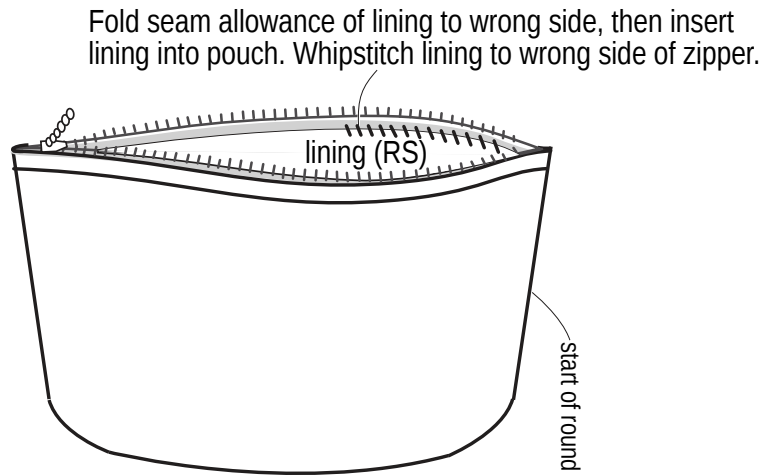
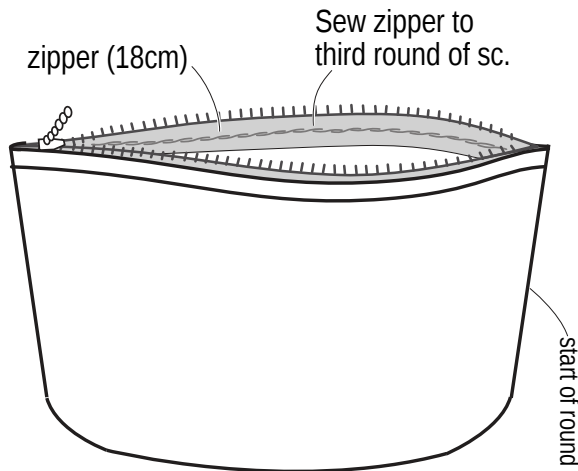

Fold seam allowance of lining to wrong side, then insert lining into pouch. Whipstitch lining to wrong side of zipper.