

214a-27 Striped Vest



Suggested yarn:

- Pierrot Yarns Junmo Namibuto2/Pure Wool [100% superwash wool; 79 yds/72m per 1.41 oz./40g skein];
 - color #5 ultramarine, 1 skein [35g]
 - color #15 golden orange, 2 skeins [75g]
 - color #23 rose red, 2 skeins [70g]

Tools/Notions:

- 3.5mm (US E) crochet hook or size necessary to achieve gauge
- 3.6mm (approx. US 4) knitting needles or size necessary to achieve gauge
- 1 button (30mm/1.18")

Finished measurements:

- chest 68.5cm/27"
- cross back width 28cm/11.02"
- back length 36cm/14.17"

Gauge (10cm/4" square):

- striped dc (US): 19 sts and 10 rows
- k1p1 ribbing: 18 sts and 34 rows

Gauge may vary according to individual crochet style. Change hook size if necessary to achieve gauge. Alternatively, rework pattern with your own gauge measurements.

Summary

✳️**Note:** Like all Japanese patterns, stitch counts given here for foundation chains do **not** include any chain sts needed for turning posts.

Back: Work foundation chain to begin. Work in striped dc.

Front: For right front, work 23-stitch foundation chain to begin, then cut yarn. Join yarn again where indicated on chart. Work in striped dc according to schematic and chart. For left front, work foundation chain and striped dc according to schematic.

Finishing: Seam shoulders with chain seam (alternating ch st and slip st as needed to maintain pattern). Seam sides with chain seam. With knitting needles, pick up stitches around front edges and hem; work k1p1 ribbing. Pick up stitches around neckline (including ends of ribbing just worked at right and left front). Work k1p1 ribbing for collar, including a 3-stitch buttonhole on the left side only. Pick up stitches around each armhole; working k1p1 ribbing in the round. Bind off in pattern.

Abbreviations:

ch = chain dc = double crochet (US) k = knit p = purl PU = pick up

Back

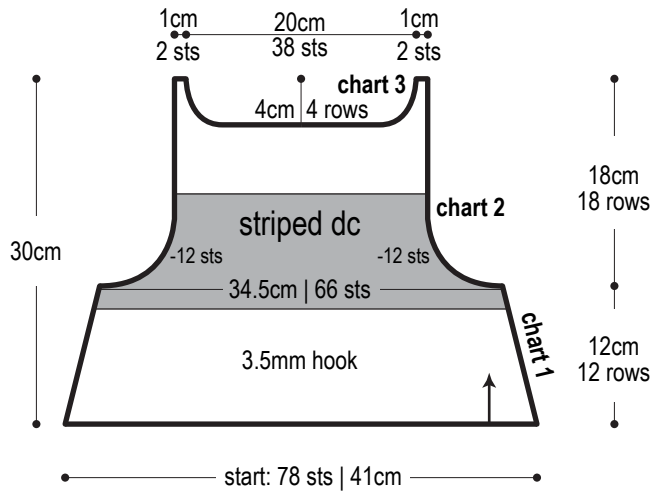

Right front

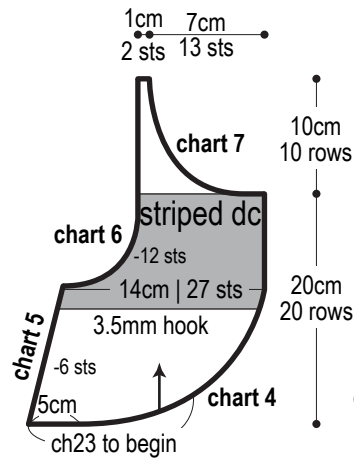

Left front

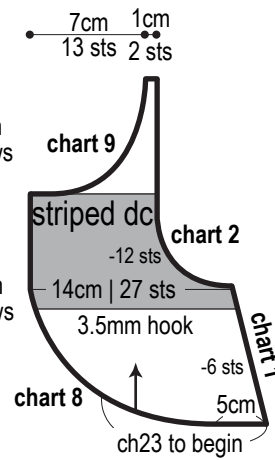

Color sequence

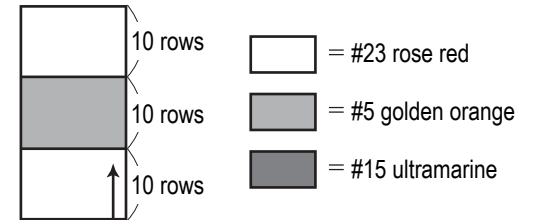

Finishing

k1p1 ribbing
3.6mm DPNs, color #15 ultramarine

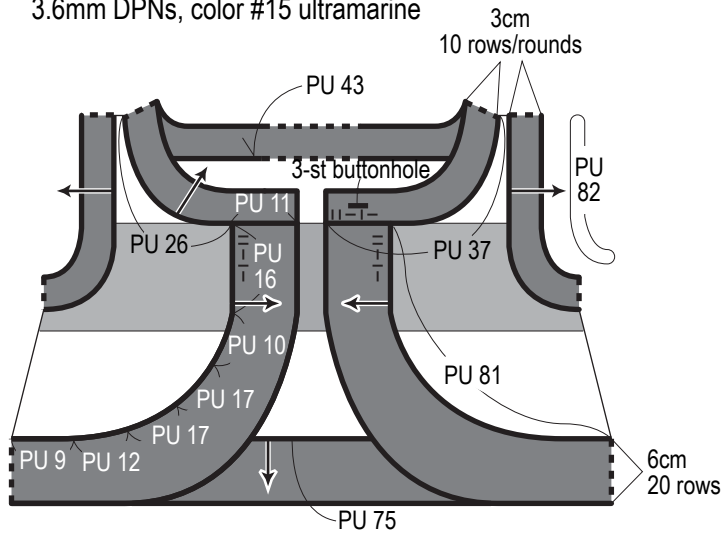

Buttonholes 3.6mm DPNs

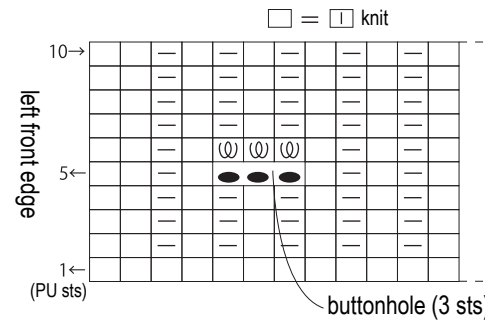

Use QR code on smartphone to view a video tutorial about how to work a three-stitch buttonhole.



※To view on computer, search on the Pierrot Yarns website or YouTube channel instead.



Right front 3.5mm hook

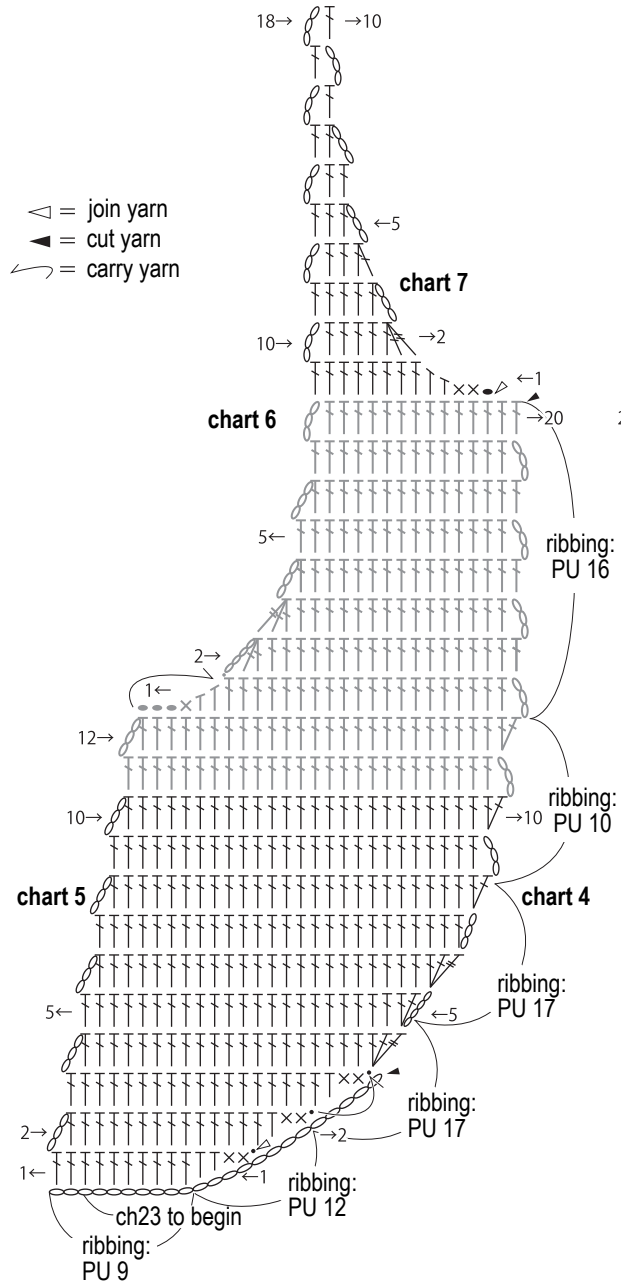

Left front 3.5mm hook

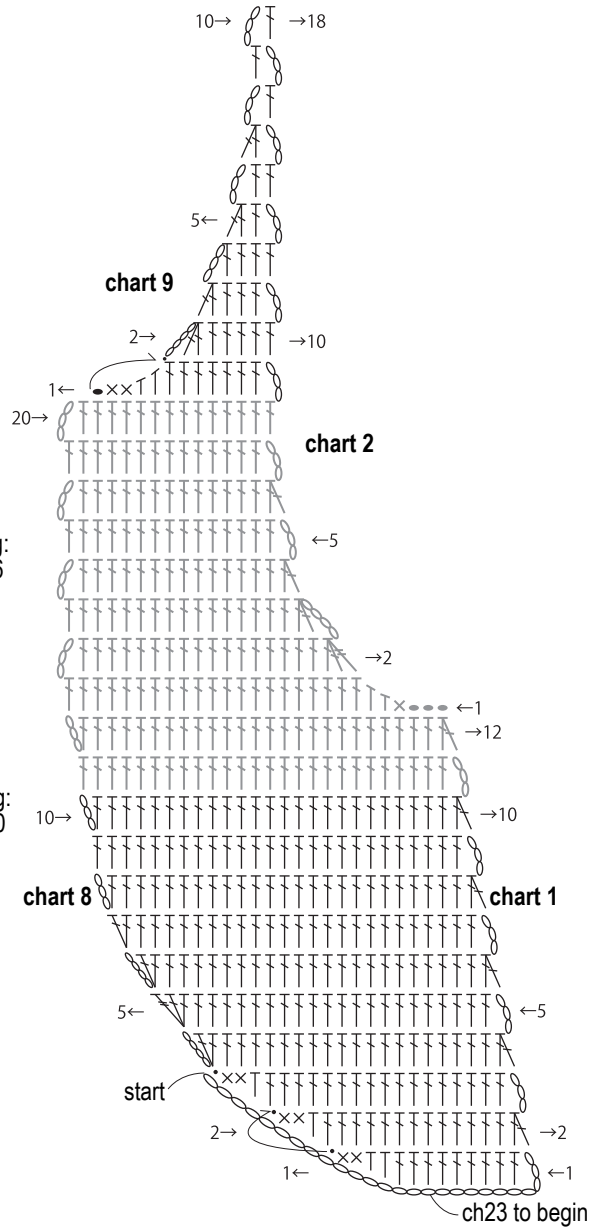

Back 3.5mm hook

