

26-27-G680RS Air Soft Room Socks



Suggested yarn:

- Pierrot Yarns Yuttari Acrylic [100% antibacterial deodorant acrylic; 73 yds/67m per 1.41 oz./40g skein];
 - bear socks: color #82 ivory, 1 skein [8g]
 - rabbit socks: color #82 ivory, 1 skein [8g]
- Pierrot Yarns Air Soft [45% acrylic, 40% wool, 15% nylon; 44 yds/40m per 1.41 oz./40g skein];
 - bear socks:
 - color #30 brown, 2 skeins [75g]
 - color #26 yellow, 1 skein [10g]
 - rabbit socks:
 - color #23 antique rose, 2 skeins [75g]
 - color #29 beige gray, 1 skein [5g]

Tools/Notions:

- 6.6mm (approx. US 10½) knitting needles or size necessary to achieve gauge
- 4.0mm (US G) and 6.0mm (US J) crochet hooks or sizes necessary to achieve gauge
- small amount polyfiber stuffing

Finished measurements:

- foot length 18.5cm/7.28"
- ankle circumference 21cm/8.27"

Gauge (10cm/4" square):

- No gauge information is provided in the original pattern.

Gauge may vary according to individual knitting style. Change needle size if necessary to achieve gauge. Alternatively, rework pattern with your own gauge measurements.

Knitting Tips

Slippers: Cast on with long-tail cast-on method. Work in garter stitch. Work decreases at tip of toe. Leaving toe stitches live (i.e., do not bind them off), cut yarn, leaving 80cm/31.50" tail. Pick up stitches from cast-on edge. Work instep section in garter stitch. Increase as shown on chart. When finished, leave stitches live (i.e., do not bind them off). Using yarn tail, thread yarn through live stitches at toe, then with right sides facing, seam instep with slip stitch. Fold instep section inside-out (i.e., with wrong sides facing each other). Using yarn tail from bind-off, whipstitch together, working into odd rows only and sewing into stitch one in from the edge. Crochet bear or rabbit motif (see below) and fasten to slipper.

Decorative bear and rabbit motifs: Create magic ring, ch1 for turning post, and work 8 single crochet (US) stitches into magic ring. Work through round 6 according to chart. Insert stuffing. On round 7, slip stitch all remaining stitches together. Join yarn and crochet either rabbit or bear ears onto face piece. Bind off ears by working slip stitch into face piece.

Abbreviations:

BO = bind off
ch = chain
CO = cast on
m = magic ring
sc = single crochet (US)
= rows-stitches-times

Slipper instructions

□ = □ knit

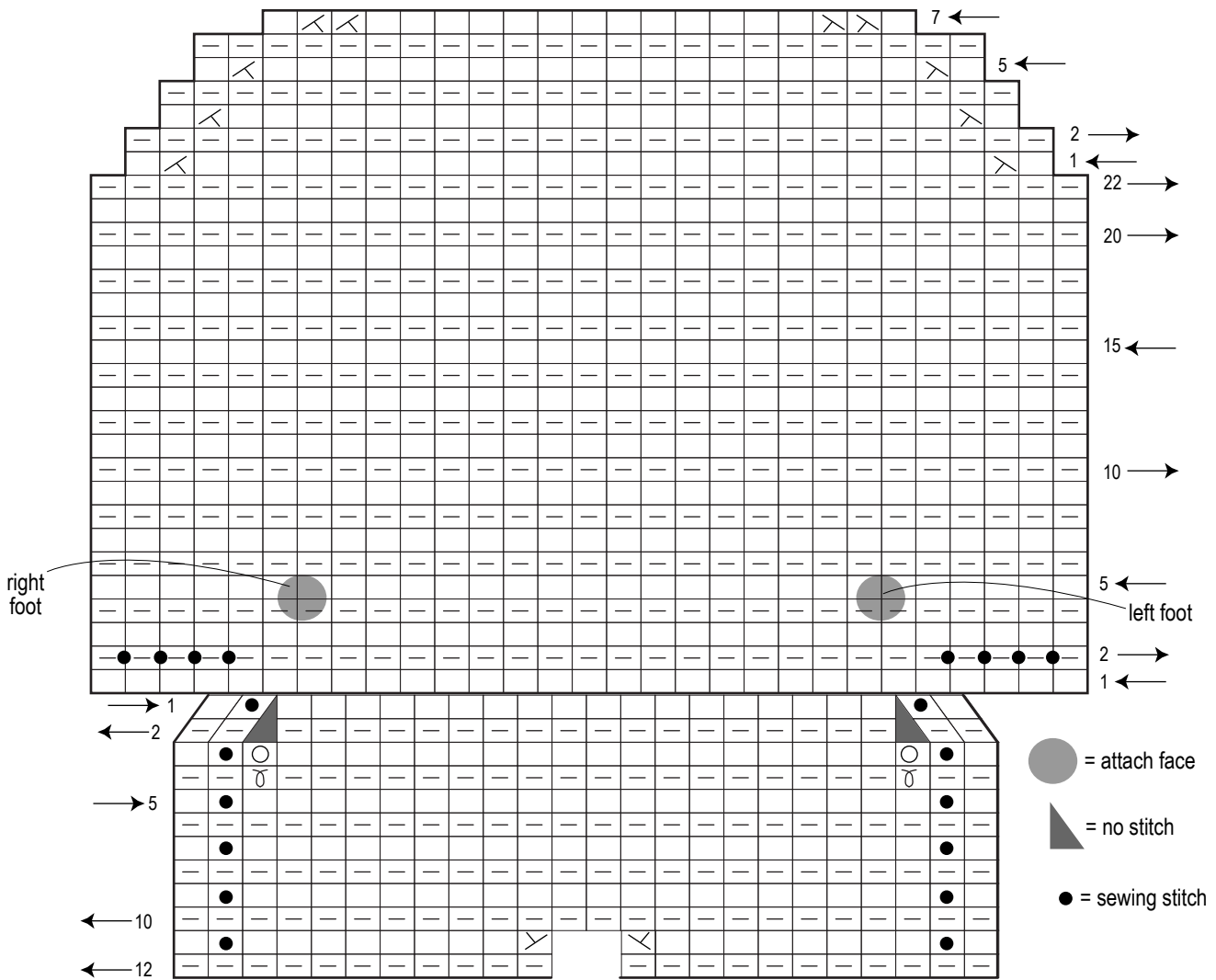

Finishing: rabbit socks

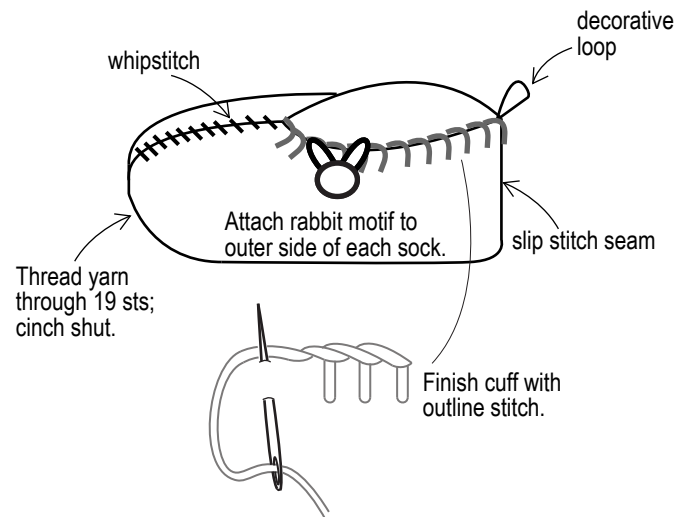
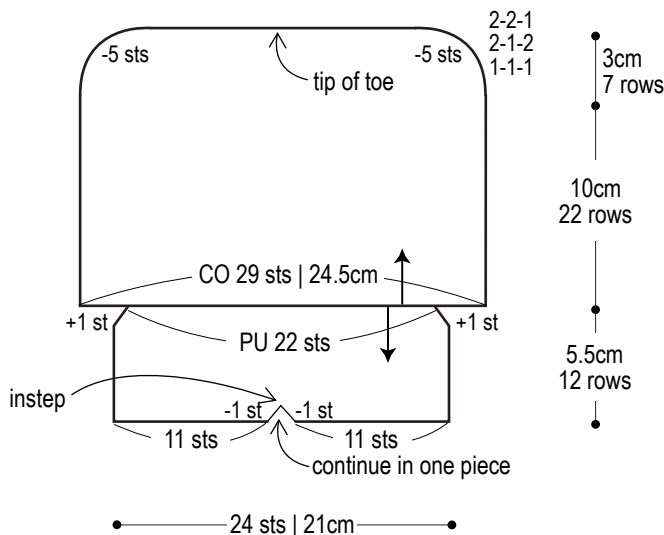

Finishing: bear socks

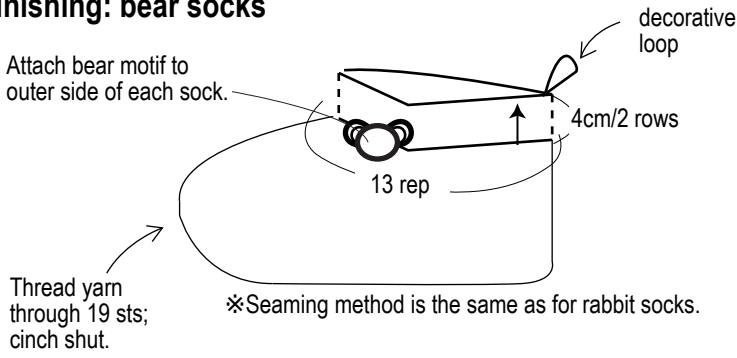

Decorative loop (4.0mm hook)

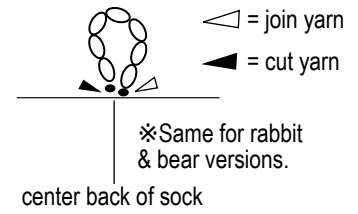

Edging (6.0mm hook)

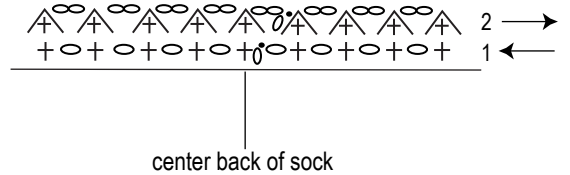

Bear & rabbit motif instructions

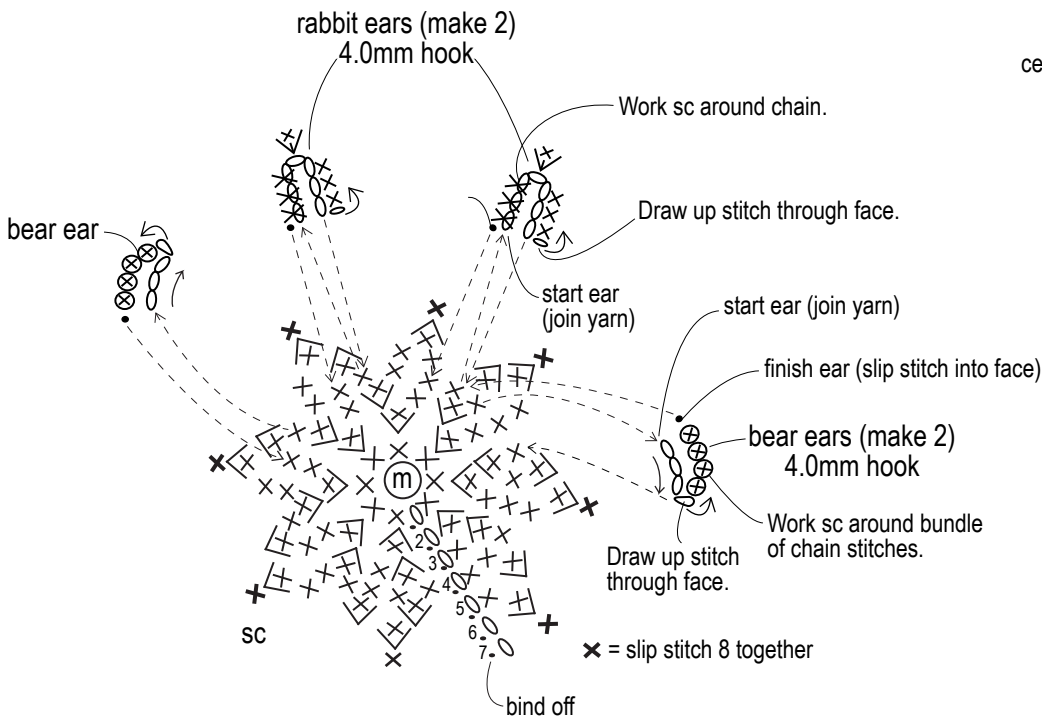

Face (4.0mm hook)

- round 7: 1 st (sl 8 tog)
- round 6: 8 sts } -8 per round
- round 5: 16 sts }
- round 4: 24 sts (work even)
- round 3: 24 sts } +8 per round
- round 2: 16 sts }
- round 1: sc 8 into magic ring

Order of construction

