

28-12 Saratto UV Camisole



Suggested yarn:

- Pierrot Yarns Saratto UV [60% acrylic, 40% cotton; 79yds/72m per 1.06 oz./30g skein]; color #9 burnt amber, 7 skeins [190g]

Tools/Notions:

- 3.0mm (approx. US C or D) and 4.0mm (US G) crochet hooks or sizes necessary to achieve gauge
- 3 buttons (20mm/0.79" diameter)

Finished measurements:

- bust 91.5cm/36.02"
- length 51cm/20.08"

Gauge (10cm/4" square):

- pattern stitch: 22.5 sts and 7.5 rows

Gauge may vary according to individual crochet style. Change hook size if necessary to achieve gauge. Alternatively, rework pattern with your own gauge measurements.

Crochet Tips

Body: Chain to create foundation row and, working into bottom loops of chain, begin crocheting. Fronts and back crocheted in one piece. Work edging A at hem. Join yarn at corner of edging on right front and working edging B.

Finishing: Crochet shoulder straps and attach to garment. Crochet cord for belt and thread through fabric at waist. Crochet decorative edgings for belt. Attach buttons.

Abbreviations:

ch = chain
m = magic ring
sc = single crochet (US)

Front and back

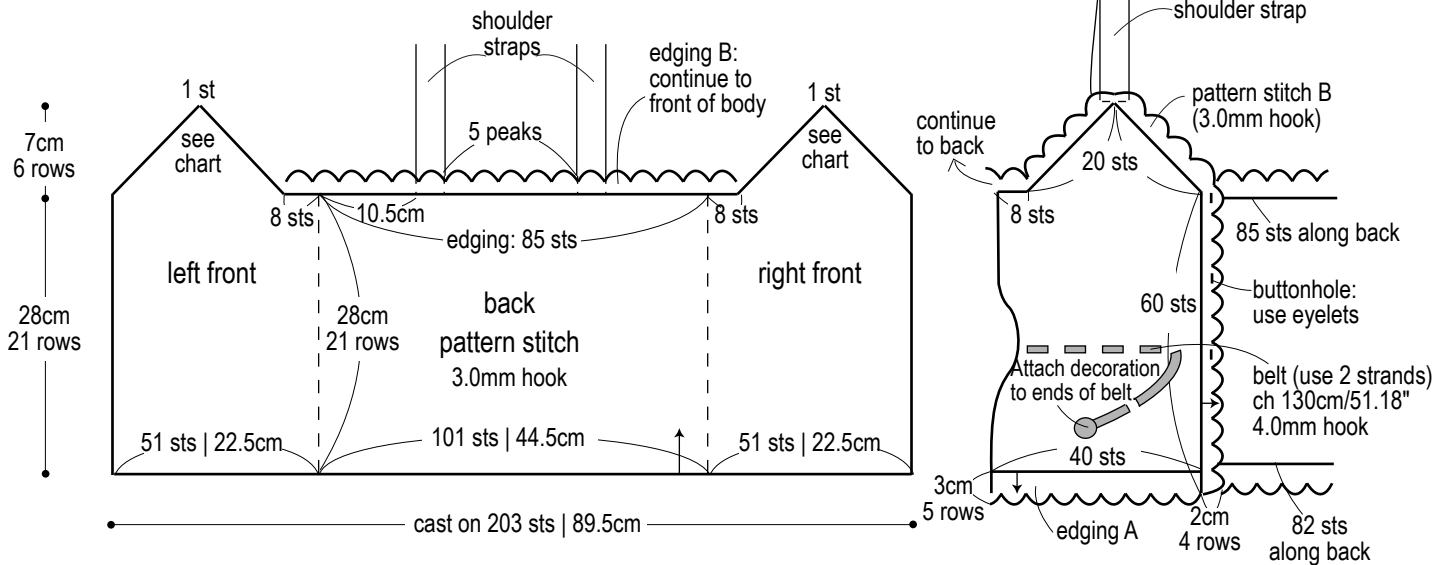

Pattern stitch

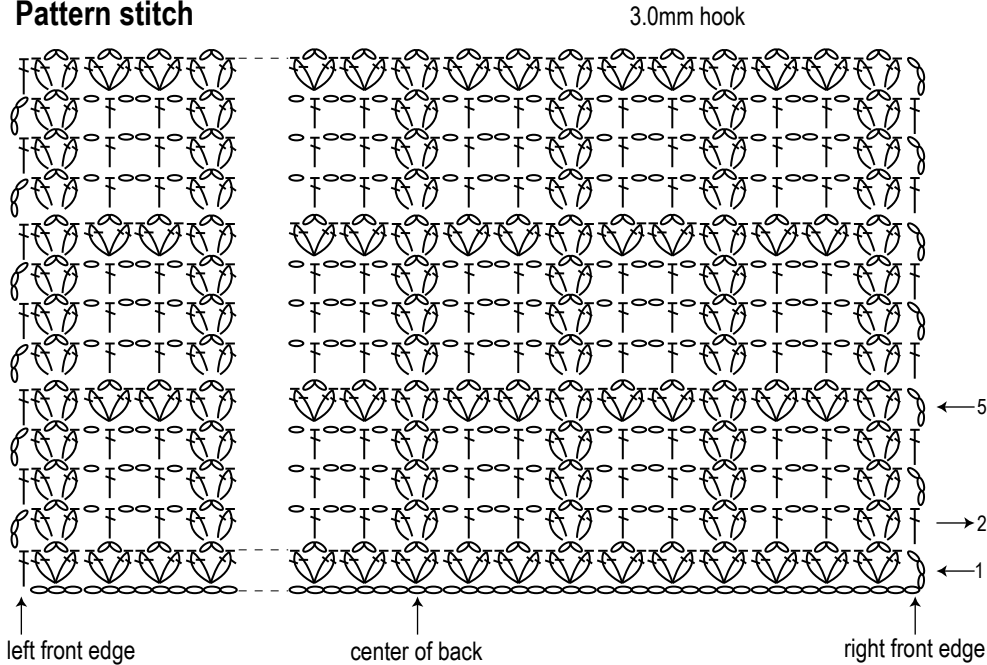

Shoulder straps (make 2)

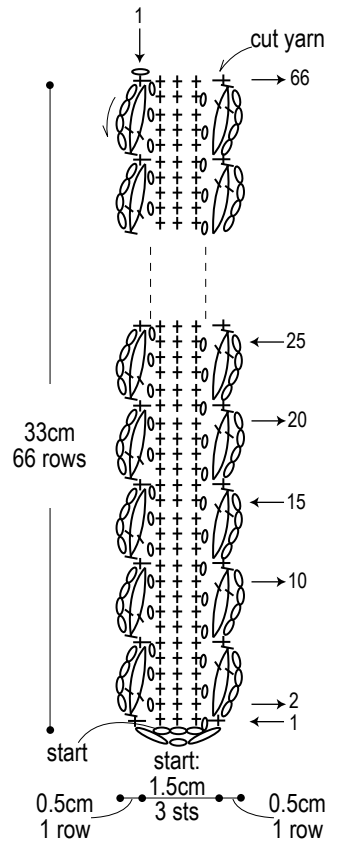

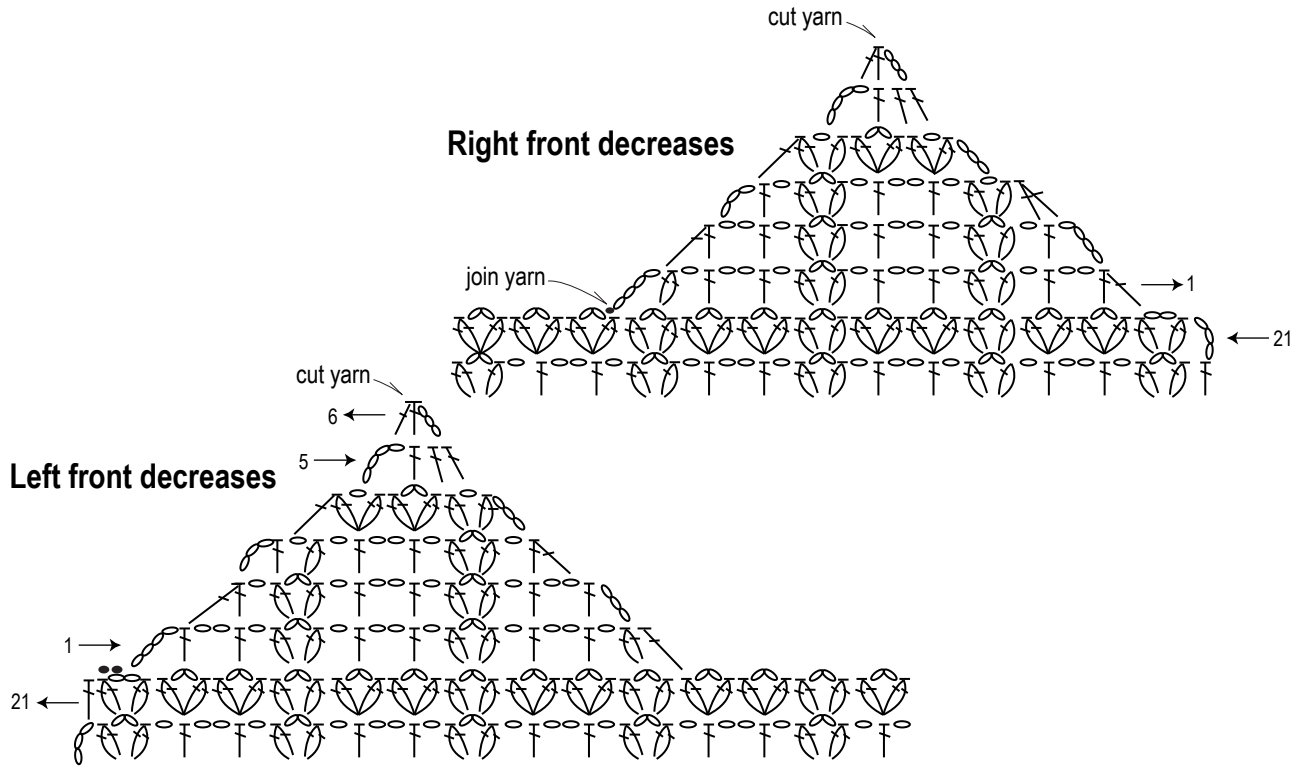

Edging A (3.0mm hook)

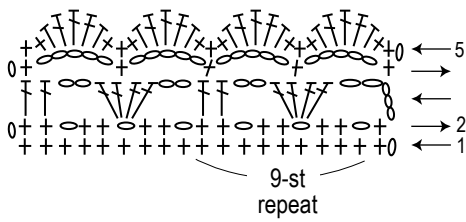

Edging B (3.0mm hook)

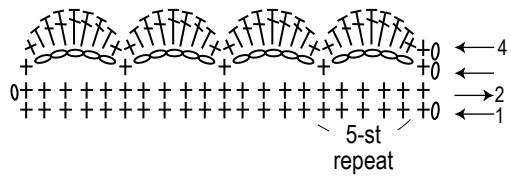

How to thread belt

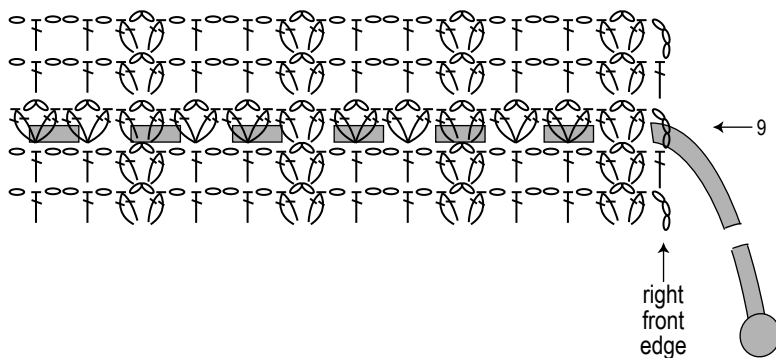

Belt decorations

