

215s-11 Ortega-style Backpack



Suggested yarn:

- Pierrot Yarns Amian [100% Japanese paper; 94 yds/86m per 1.41 oz./40g skein];
 - color #21 ivory, 2 skeins [45g]
 - color #22 teal green, 2 skeins [45g]
 - color #25 Naples yellow, 1 skein [20g]
 - color #28 burnt umber, 3 skeins [95g]
- Pierrot Yarns Amian Space Dyed [100% Japanese paper; 94 yds/86m per 1.41 oz./40g skein];
 - color #11 deep blue, 1 skein [35g]

Tools/Notions:

- 3.5mm (US E) crochet hook or size necessary to achieve gauge

Finished measurements:

- Please see finishing schematics.

Gauge (10cm/4" square):

- single crochet (US) stitch & pattern stitch: 20 sts and 20 rounds

Gauge may vary according to individual crochet style. Change hook size if necessary to achieve gauge. Alternatively, rework pattern with your own gauge measurements.

Summary

❖**Note:** Like all Japanese patterns, stitch counts given here for foundation chains do **not** include any chain sts needed for turning posts.

Body of bag: Create magic ring to begin bottom, then work sc in the round, increasing as indicated. Continue from bottom to sides; work pattern stitch back and forth in joined rounds. When working pattern stitch, do not cut yarn; instead, work main color over the top of resting color (so that resting color is entirely encased in stitches made of main color).

Shoulder straps (2) & drawstring closure: Work foundation chain to begin, then work each shoulder strap flat. Work drawstring closure in the round. Seam drawstring closure down the center with half blindstitch.

Finishing: Crochet drawstring, then thread through bag where indicated. Thread drawstring through drawstring stopper, then tie knots at ends of drawstring. Sew shoulder straps to bag.

Abbreviations:

ch = chain m = magic ring/circle sc = single crochet (US)

Bottom

3.5mm hook, color #28 burnt umber

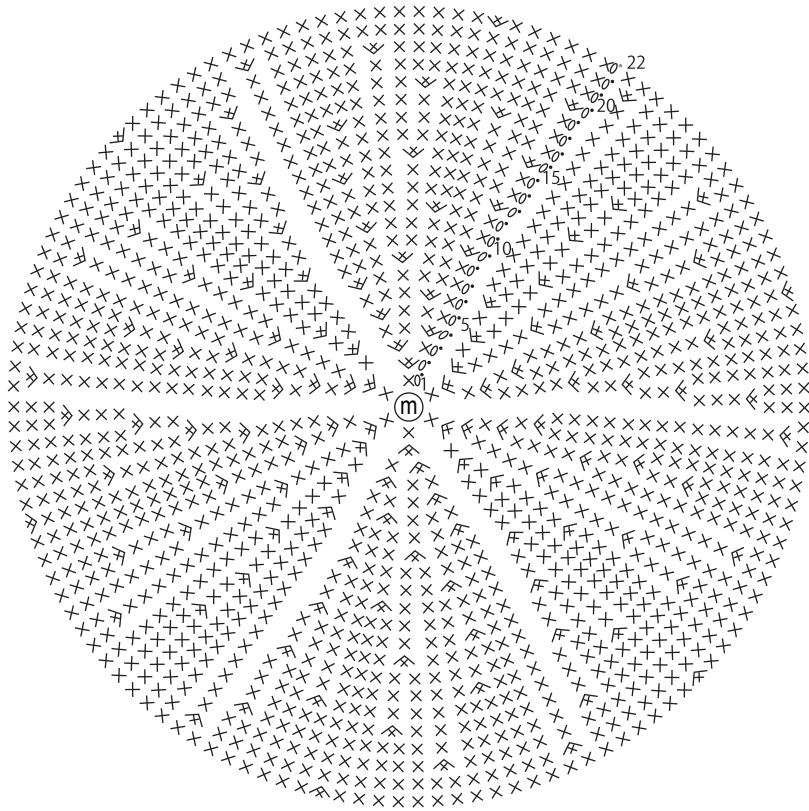

round no.	stitch count
22	132
21	126
20	120
19	114
18	108
17	102
16	96
15	90
14	84
13	78
12	72
11	66
10	60
9	54
8	48
7	42
6	36
5	30
4	24
3	18
2	12
1	6 (work into magic ring)

+6 sts per round

Backpack schematic

3.5mm hook

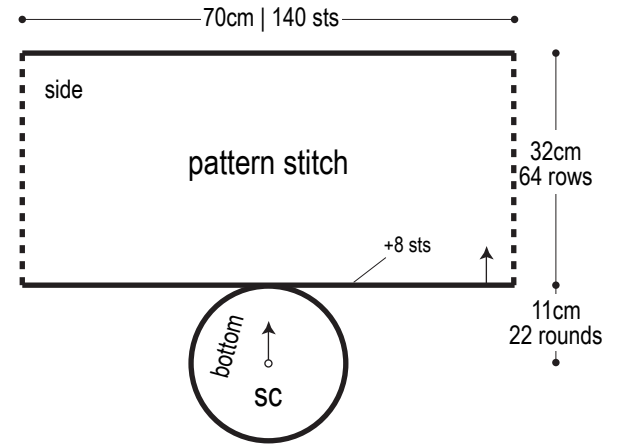

Finishing

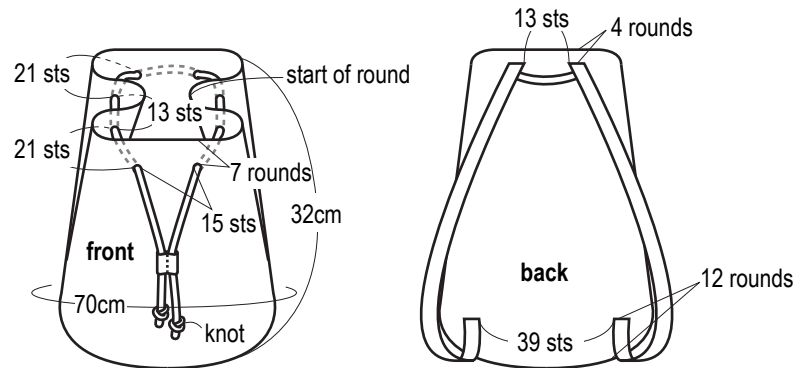

Side 3.5mm hook

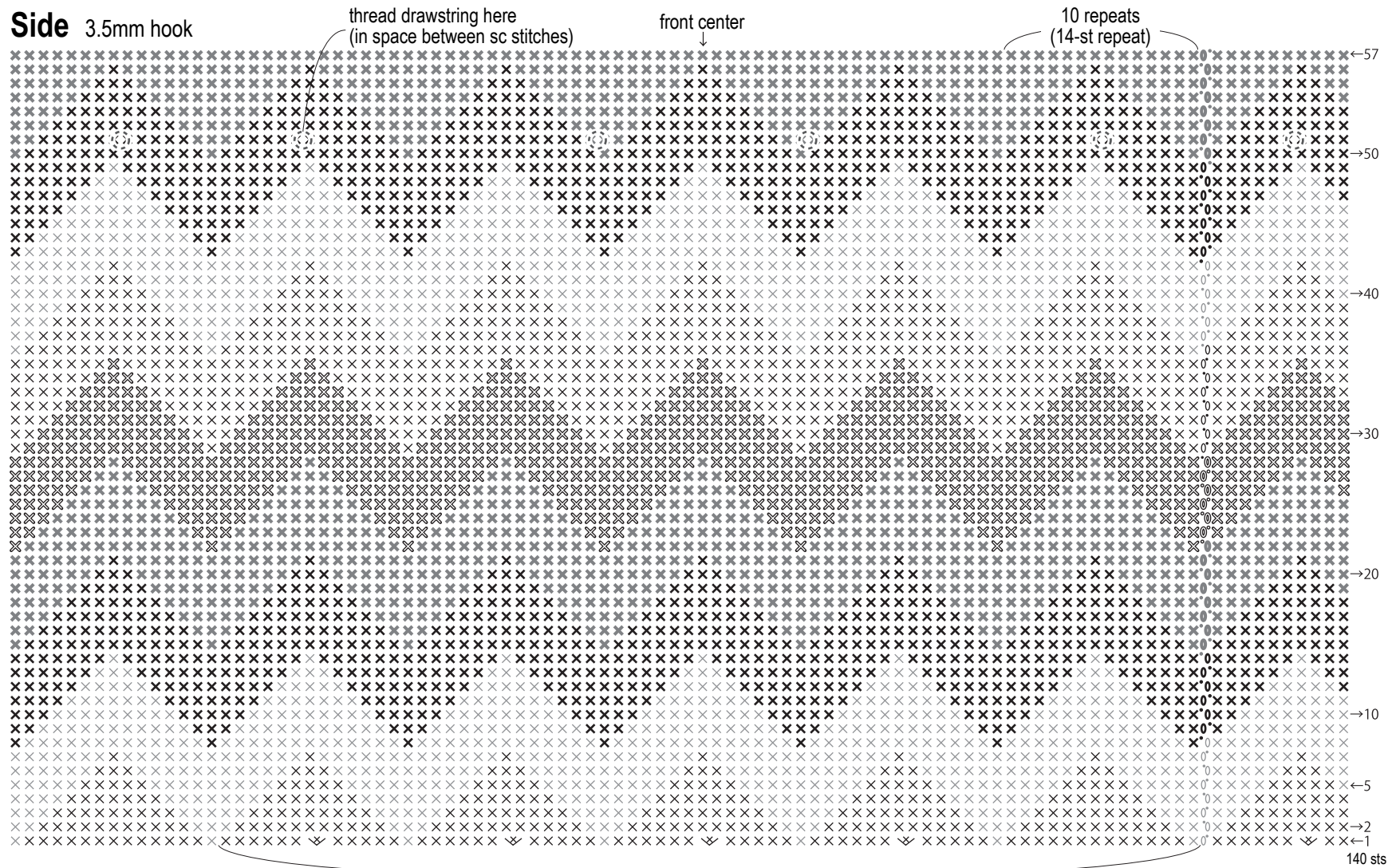

first round only:
repeat 2 times

- = Amian, color #28 burnt umber
- = Amian, color #22 teal green
- = Amian, color #21 ivory
- = Amian Space Dyed, color #11 deep blue
- = Amian, color #24 Naples yellow

Drawstring

3.5mm hook, color #28 burnt umber

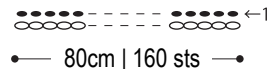

Drawstring stopper

3.5mm hook, color #28 burnt umber

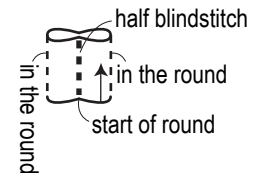
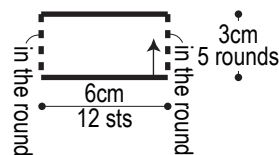

Shoulder strap (make 2)

3.5mm hook, color #28 burnt umber

