

# 211-7h Black Silk Suit



## Suggested yarn:

• Pierrot Yarns Silk Silpalon [50% silk, 50% silpalon acrylic; 273 yds/250m per 1.76 oz./50g cone]; color #6120 black, 10 cones [500g]

## Tools/Notions:

• 2.3mm (approx. US B) and 2.5mm (approx. US B or C) crochet hook or size necessary to achieve gauge  
• 66cm/25.98" length of black elastic for waistband (2.5cm/0.98" wide)

## Finished measurements:

• bust 92.5cm/36.42"  
• cross back width 35cm/13.78"  
• jacket length 55cm/21.65"  
• sleeve length 54cm/21.26"  
• waist 64cm/25.20"  
• hips 98cm/38.58"  
• skirt length 68cm/26.77"

## Gauge (10cm/4" square):

• pattern stitch A: 34 sts and 13.5 rows

Gauge may vary according to individual crochet style. Change hook size if necessary to achieve gauge. Alternatively, rework pattern with your own gauge measurements.

## Crochet Tips

**Front and back:** Chain to cast on; work front and back in one piece in pattern stitch A. Working in bottom loops of foundation row, work peplum in pattern stitch B. Seam shoulders with a chain seam. Seam sides with a chain seam. Work edging in the round around neckline, front edges, and hem.

**Sleeves:** Chain to cast on; work in pattern stitch A. Seam sleeves with a chain seam. Work edging in the round around cuffs.

**Skirt:** Chain to cast on; work 2 pieces in pattern stitch A. Seam sides with a chain seam. Working into stitches of foundation chain, work peplum in pattern stitch B' back-and-forth in joined rounds. Work edging in the round. Working into waist edge of skirt, work belt in the round.

**Finishing:** Crochet 6 cords. Fasten cords where indicated. Join sleeves to body with a chain seam. Insert black elastic into belt you created earlier. (Form a ring with elastic, overlapping by 2cm/0.79", and sew.)

## Abbreviations:

ch = chain

dc = double crochet (US)

fpdc = front post double crochet (US)

rep = repeat(s)

## Body

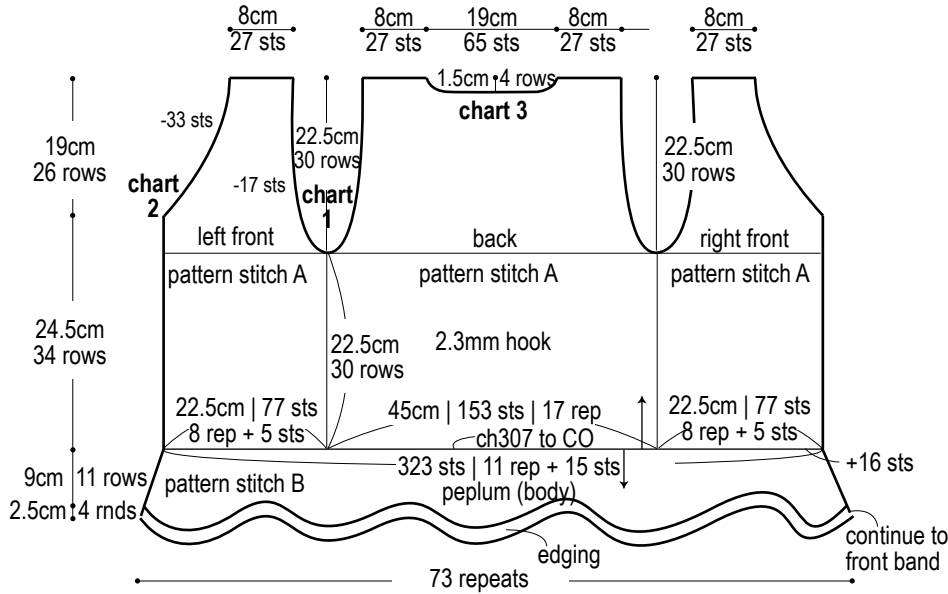

## Edging and cords

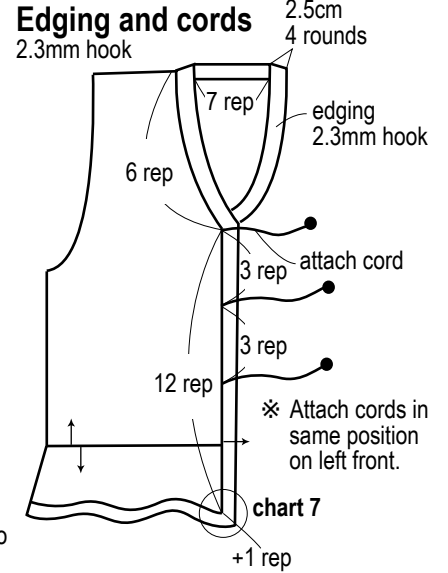

## Skirt

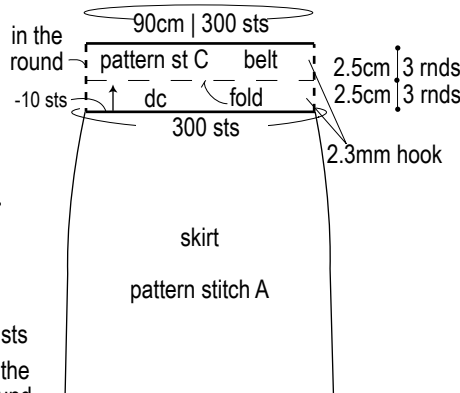
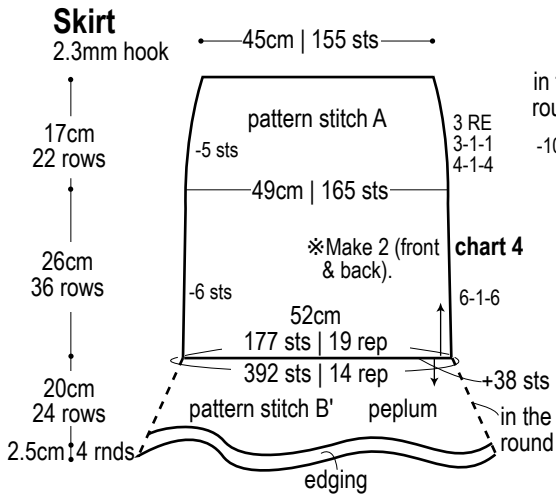

## Sleeve

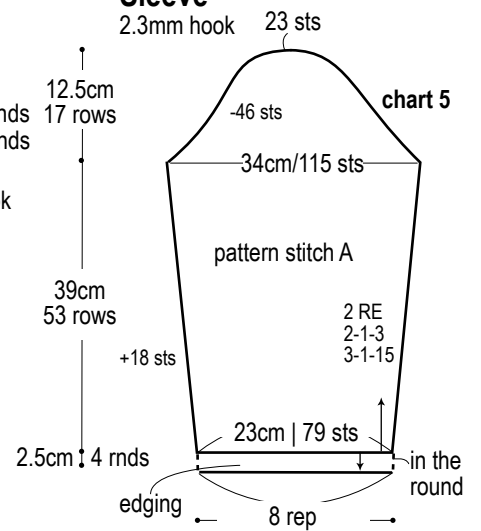

## Edging (2.3mm hook)

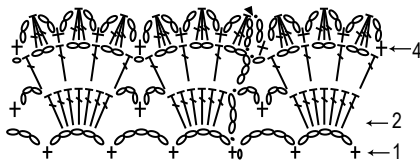

## Corner of body edging

2.3mm hook

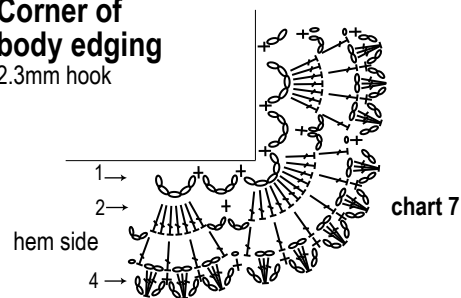

**Peplum (body)** 2.3mm hook

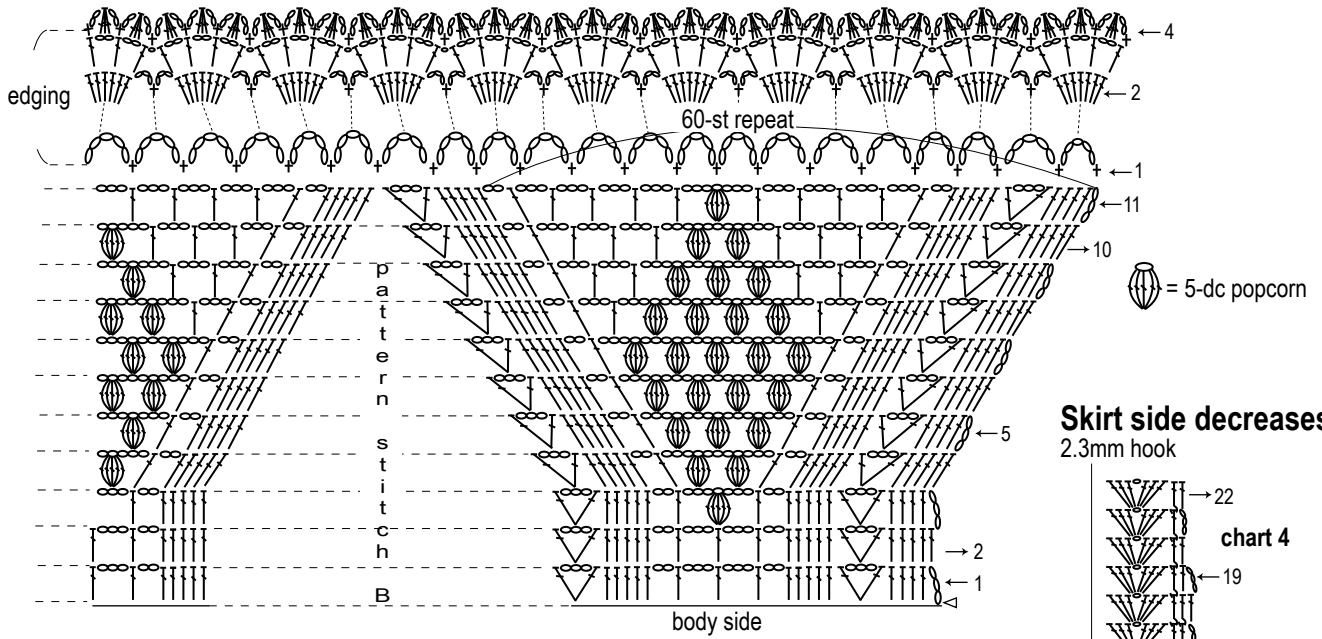

**Back** (2.3mm hook)

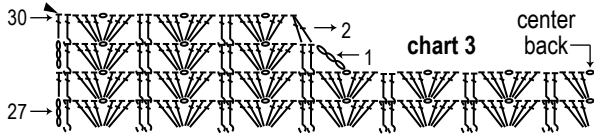

**Front & armscye** 2.3mm hook

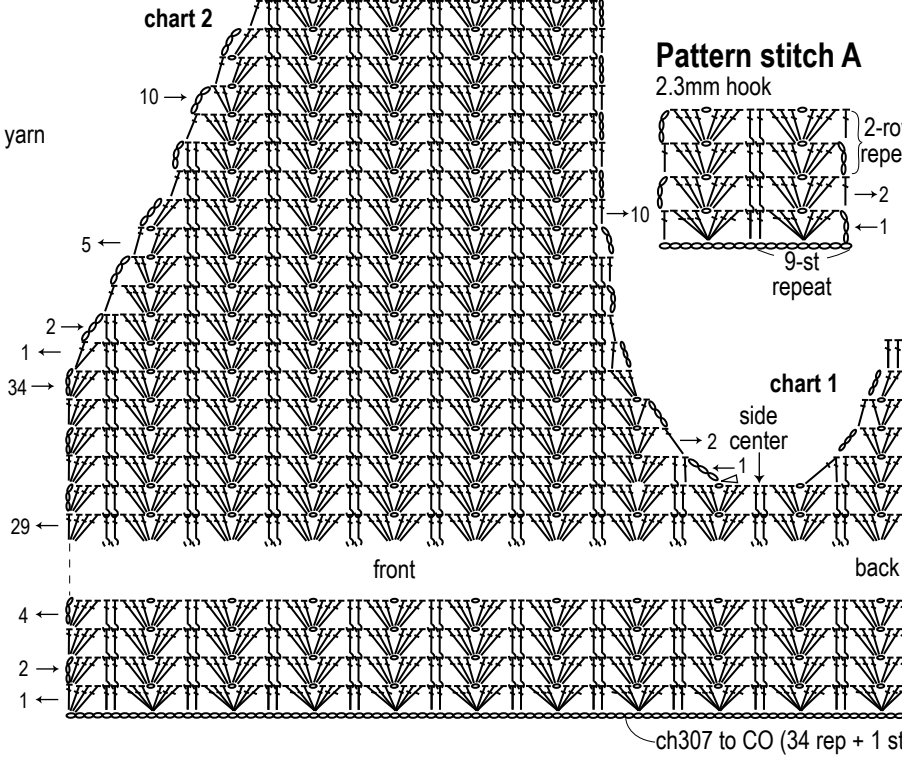

**Cords (make 6)**

2.5mm hook, 2 strands of yarn

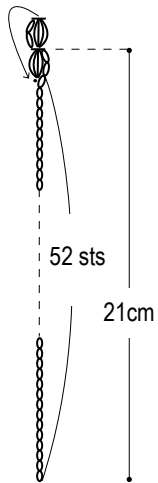

ch307 to CO (34 rep + 1 st) ch177 to CO (34 rep + 1 st)

**Sleeve side increases**

2.3mm hook

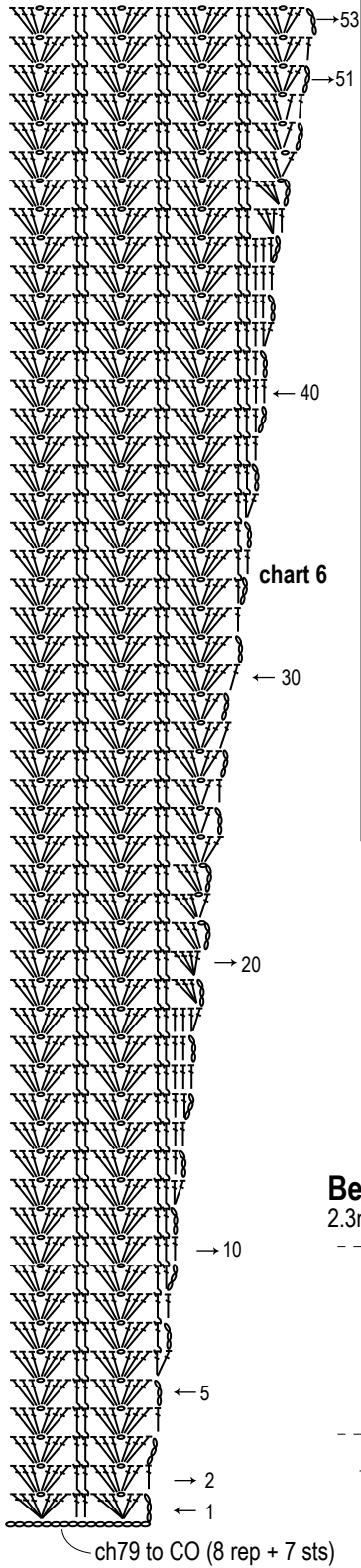

ch79 to CO (8 rep + 7 sts)

**Belt**

2.3mm hook

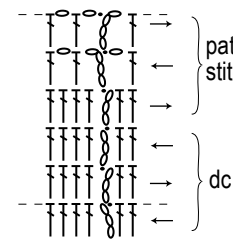

**Sleeve cap**

2.3mm hook

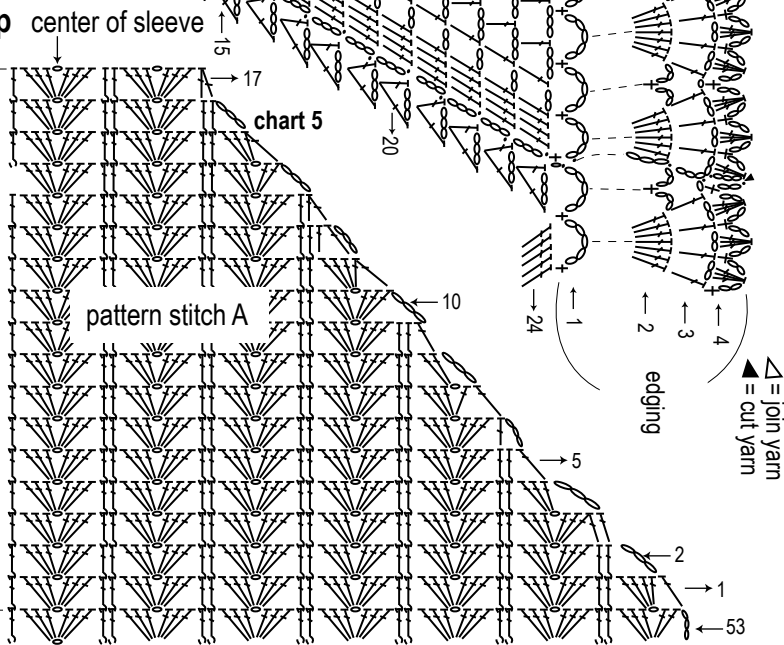

center of sleeve

**peplum (skirt)**

2.3mm hook

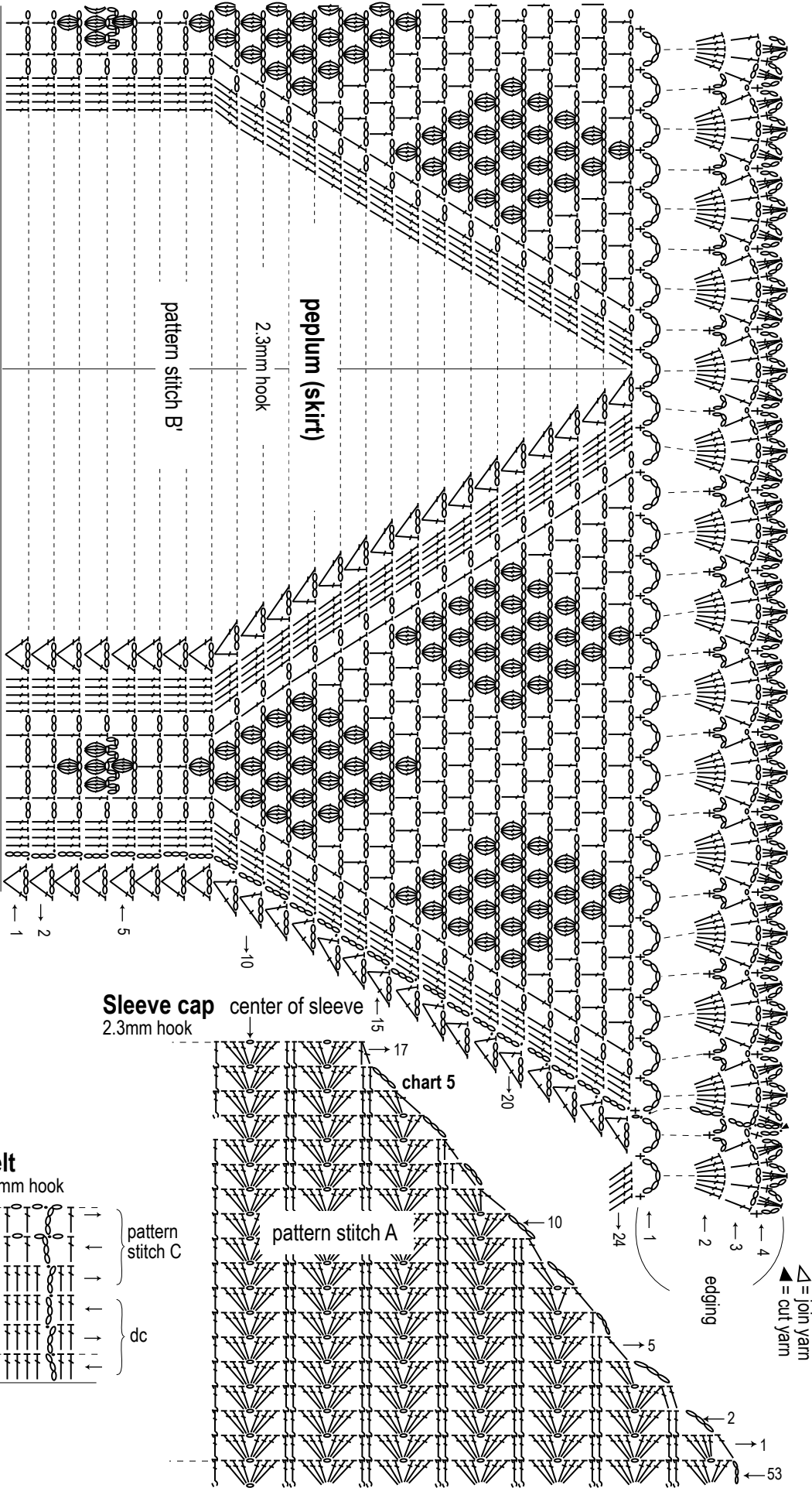

pattern stitch B

2.3mm hook

△ = join yarn  
▲ = cut yarn