

Ribbon Accent Bag

© Pierrot Yarns (Gosyo Co., Ltd.). Translation by Linda Lanz.



Materials

- Pierrot Yarns Smoothness Silk Wool [80% wool, 20% silk; 120 yds/ 110m per 1.41 oz. / 40g skein]; color #12 emerald; 8 skeins [300g]
- 3.00mm (US C or D) and 5.00mm (US H) crochet hooks or sizes necessary to achieve gauge
- 1 pair wooden purse handles, approx. 18.5cm/7.3" wide and 12.5cm/4.9" tall
- lining fabric, approx. 50cm/19.7" square

Gauge

- pattern stitch: 16 sts and 8 rows = 10cm/4" square

Finished measurements

- width 42cm/16.5"
- depth 29cm/11.4"

Crochet Tips

❖ **Note:** entire bag is worked with two strands of yarn held together.

Chain 51 and begin working in pattern stitch from the bottom up. Work increases at edges. Work the opposite side in the same way. When finished, align edges using symbols shown in schematic and seam sides using slip stitch. Cut lining according to schematics and sew as indicated; secure to inside of bag using blind stitch. Attach handles to bag and secure top fold (that is, the fold covering the handles) with blind stitch.

● bag instructions (5.0mm hook)
 ※ use 2 strands of yarn held together

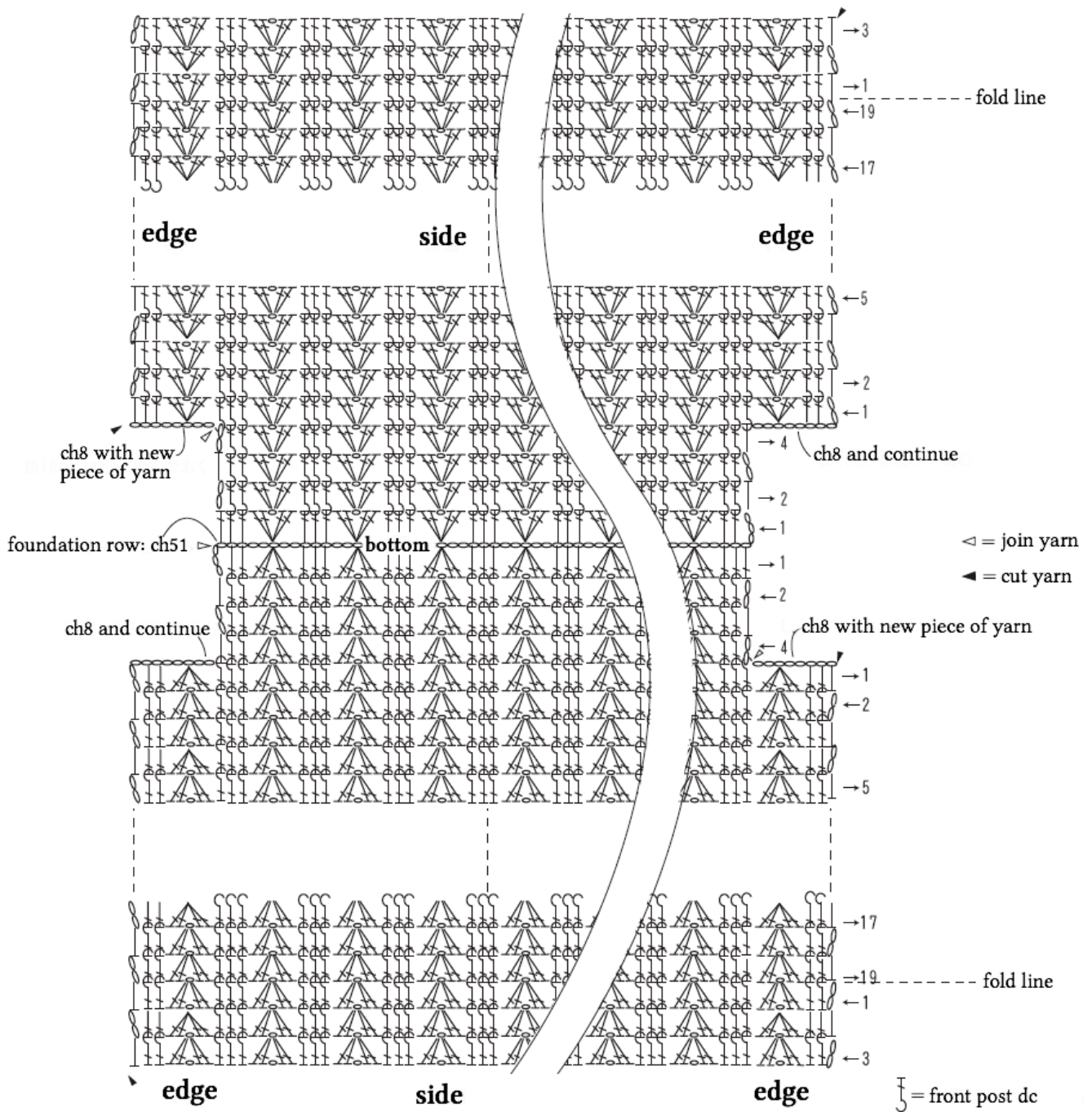

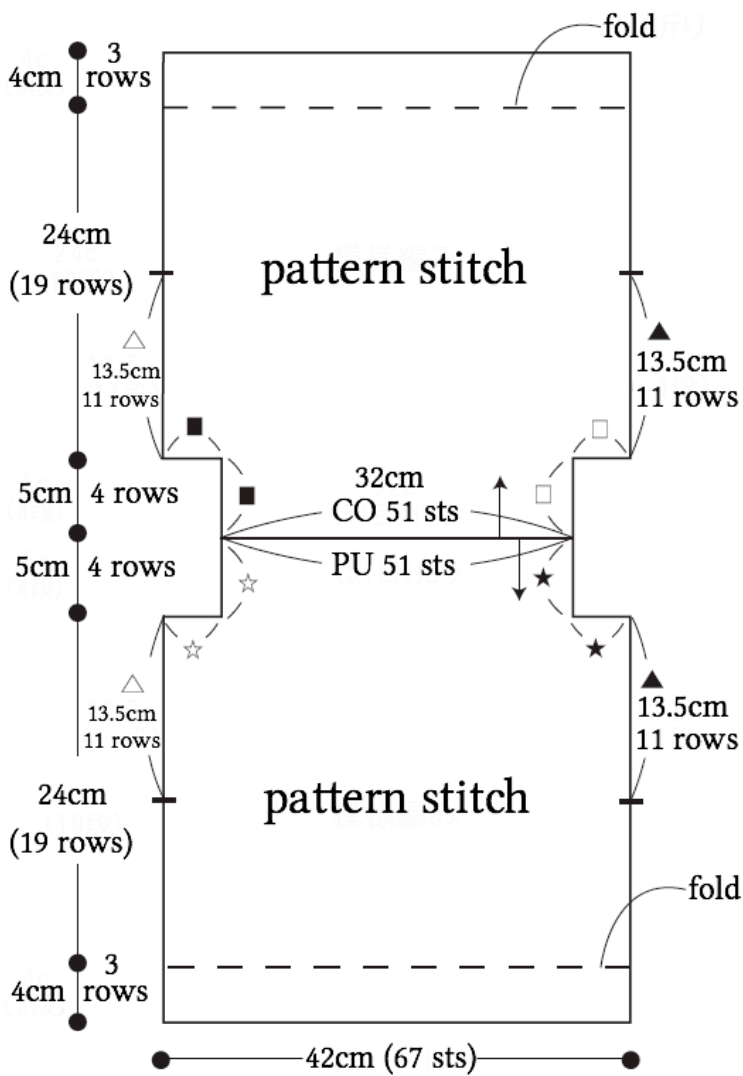

※ match \triangle \blacktriangle \square \blacksquare \star \star symbols and seam

● lining

● how to sew corners

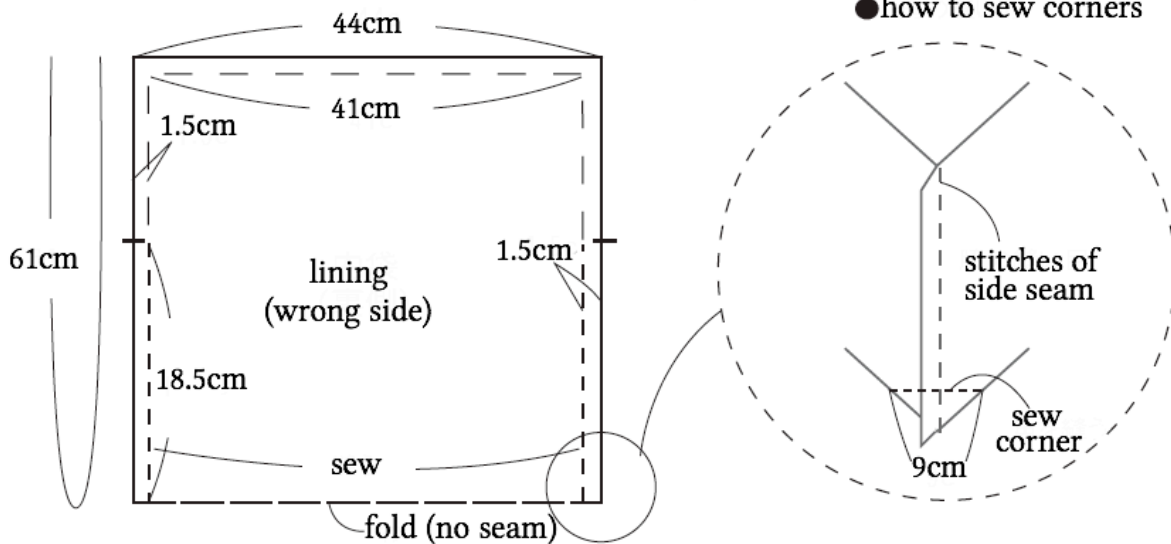

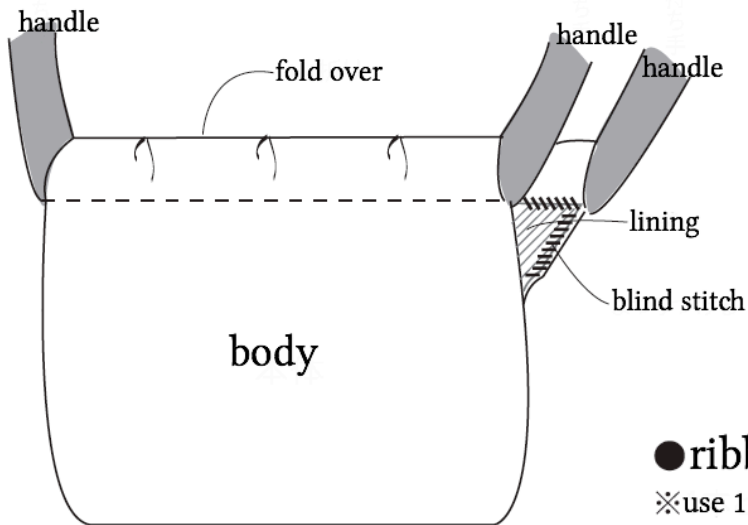

attach handles to body, then insert lining and sew down

● ribbon (3.0mm hook)

※use 1 strand of yarn

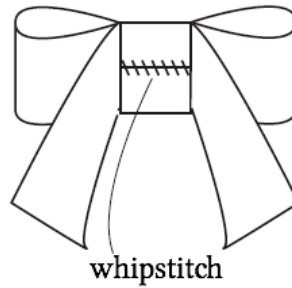
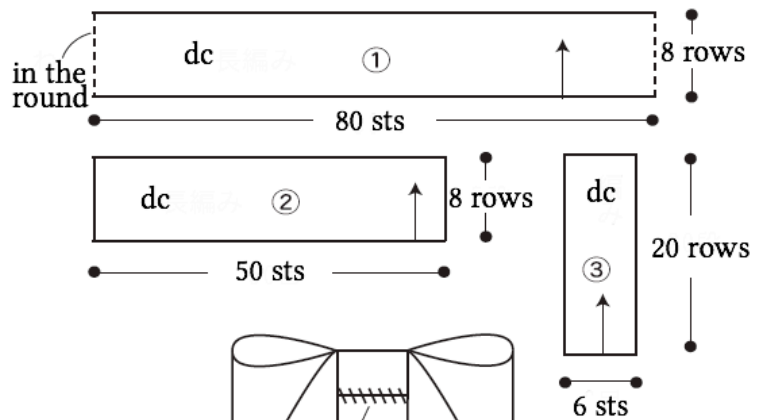

Steps:

- * Crochet piece 1 in the round.
- * Place piece 2 on top of piece 1.
- * Wrap both 1 and 2 with piece 3.

● dc

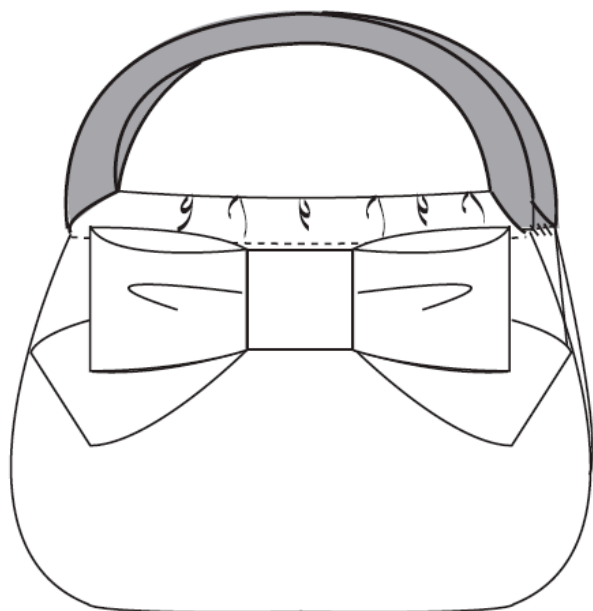
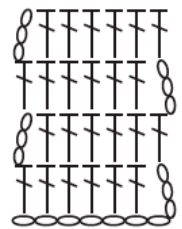

attach ribbon to bag with seams hidden