

210-2 Tunic

© Pierrot Yarns (Gosyo Co., Ltd.). Translation by Linda Lanz.



Materials

Where there are two numbers, the one in brackets refers to the ladies' version.

- Pierrot Yarns Casual Cotton Gradation [100% cotton; 120 yds/110 m per 1.1 oz / 30g skein];
 - child: color #01 pastel pink; 8 skeins [240g]
 - adult: color #04 night blue; 9 skeins [270g]
- 2.3mm [2.5mm] crochet hook or size necessary to achieve gauge; US B [C] is the closest equivalent

Gauge

Gauge measured in a swatch 10cm/4" square.

- pattern stitch A: 28 st and 12 rows [25 st and 11 rows]
- pattern stitch C: 31 st and 12 rows [27.5 st and 10 rows]

Finished measurements

- bust 78cm/30.7" [88cm/34.6"]
- back width 28cm/11" [32.5cm/12.8"]
- length 57cm/22.4" [64.5cm/25.4"]

Crochet Tips

Ladies' size: Chain 141 bottom [B] portion according to schematic. Work single crochet into 121 sts evenly spaced across top [T] portion—this will result in a decrease of 20 stitches. Crochet top [T] following charts, first in pattern stitch B, then in pattern stitch C. Join shoulder seams with woven seam technique. Join sides with whipstitch. Work 1 round of edging on hem, armholes, and neckline. Crochet drawstring and thread through bodice as indicated in schematic.

Child size: Crochet with the same number of stitches and rows as for ladies' size, but use 2.3mm crochet hook. (Crochet method is the same for both sizes.)

Note: gauge may vary according to individual. In the event you do not match stated gauge with the suggested hook size, choose another hook size.

● back

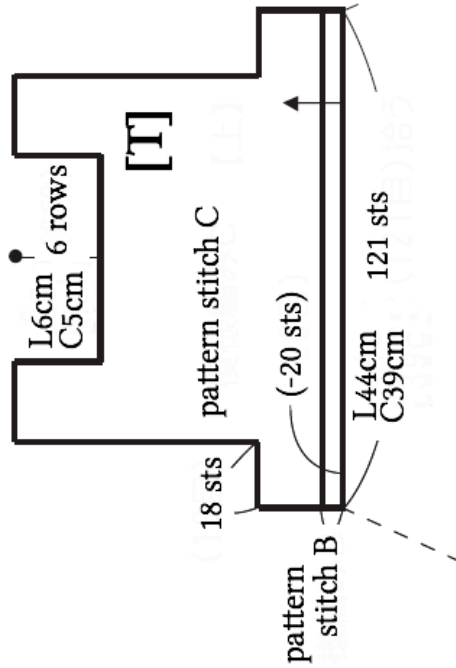
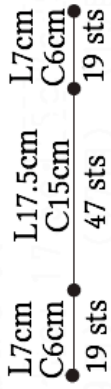

L38cm
C35cm
(42 rows)

0.5cm
(1 row)

141 sts

[T] = top; [B] = bottom

● front

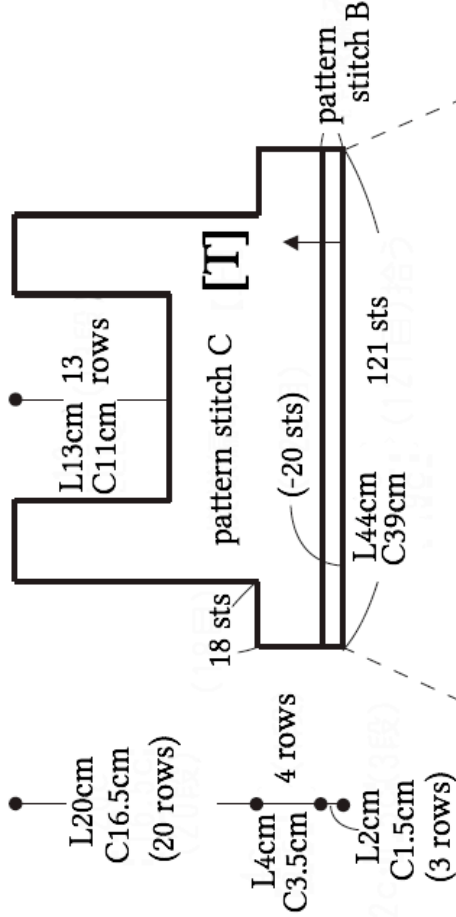
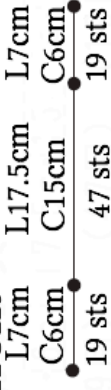

L20cm
C16.5cm
(20 rows)

L4cm
C3.5cm
(4 rows)

L2cm
C1.5cm
(3 rows)

continue crocheting

L = ladies'; C = child

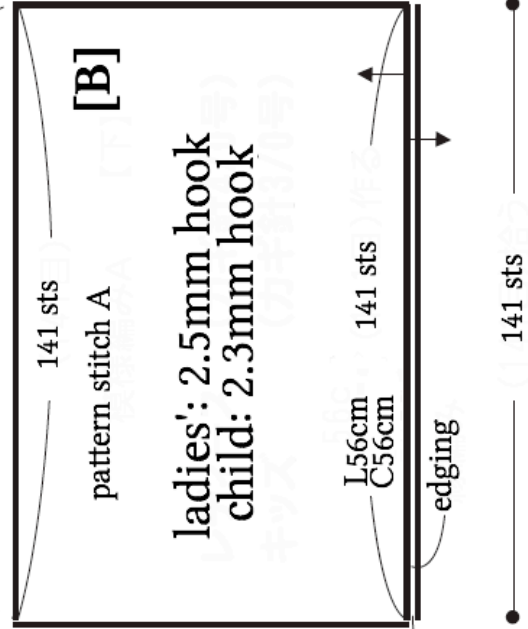

141 sts

141 sts

141 sts

● pattern stitch A

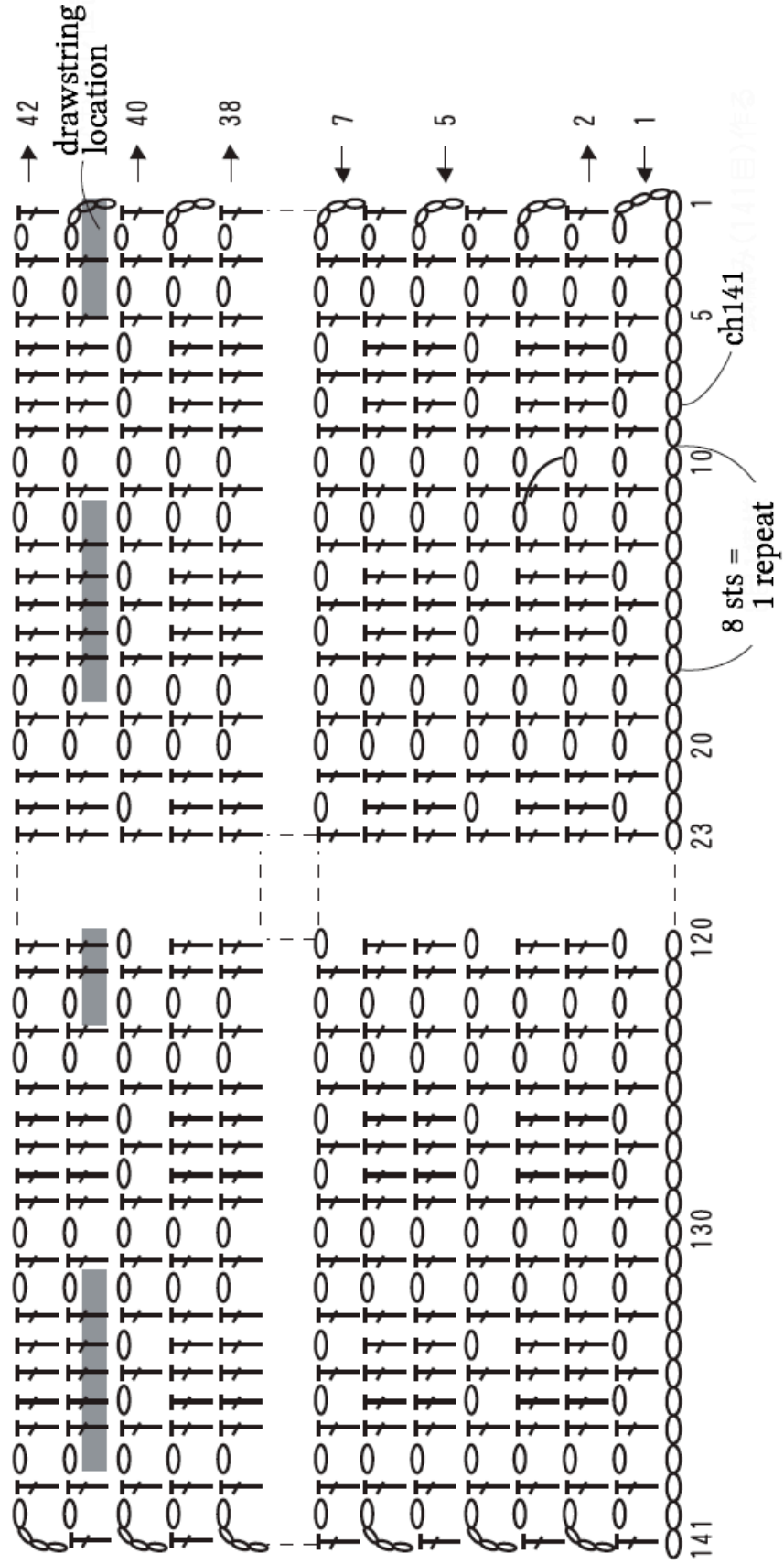

● back (top)

ladies: 2.5mm hook
 child: 2.3mm hook

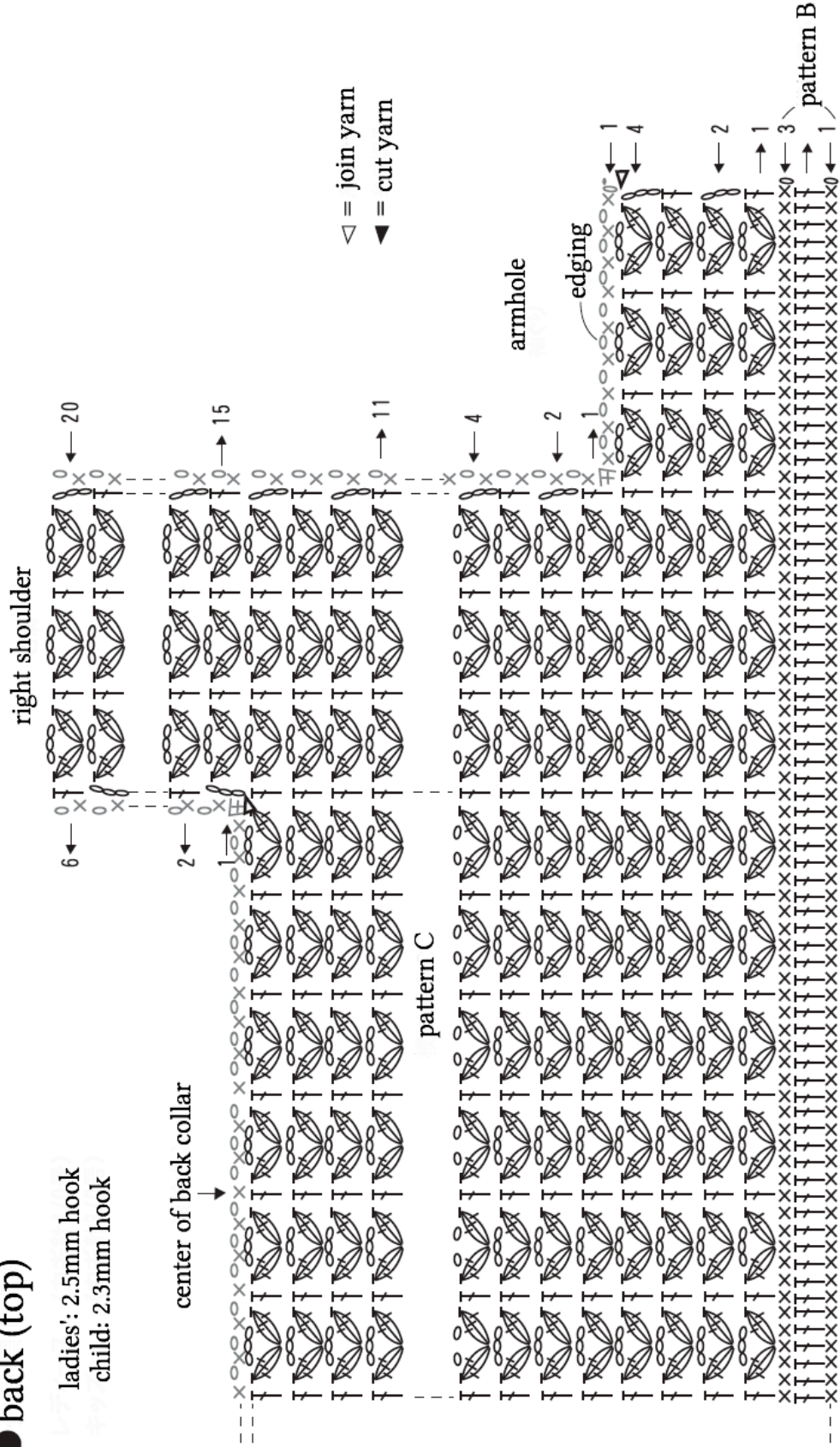

● front (top)

ladies: 2.5mm hook

child: 2.3mm hook

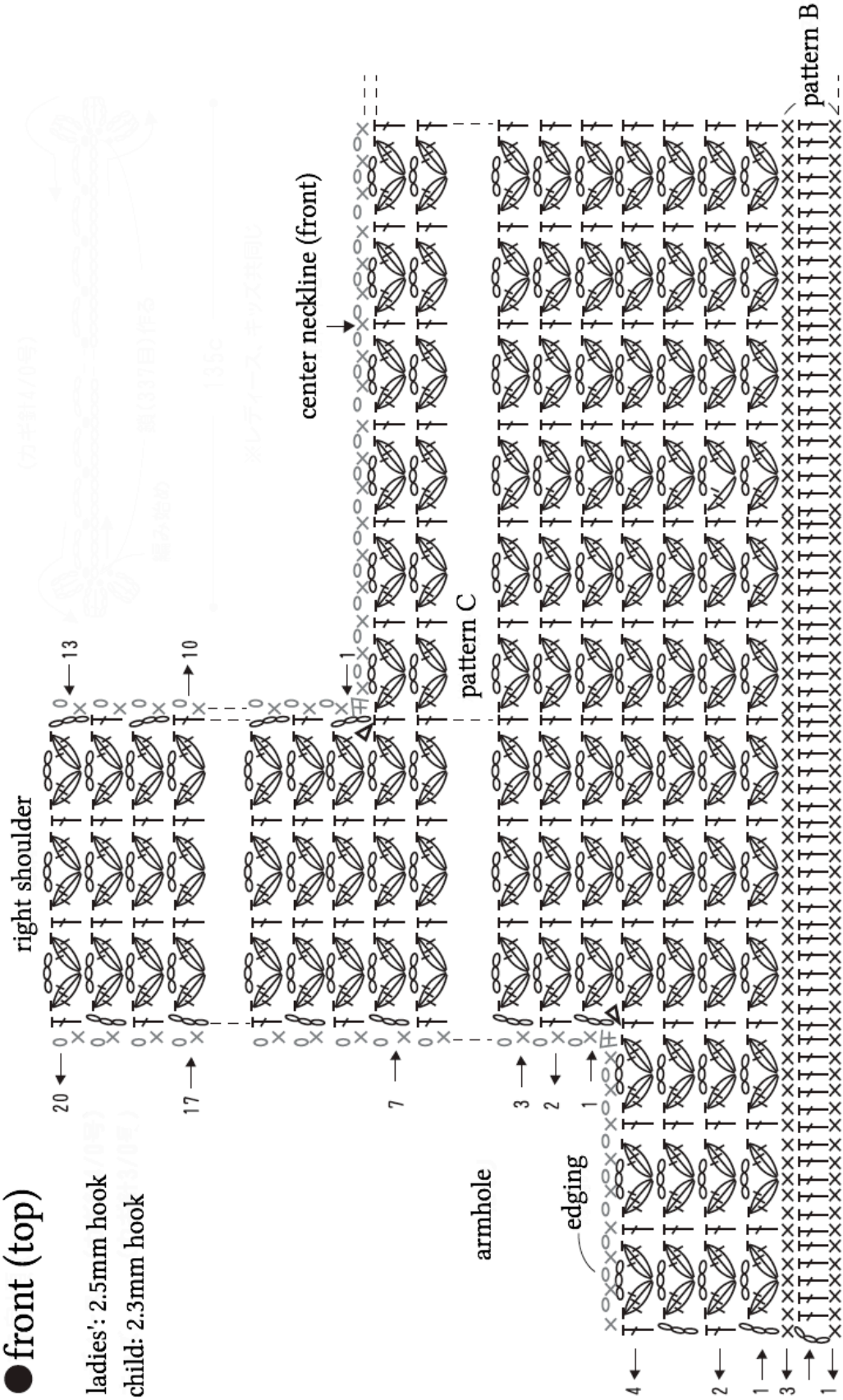

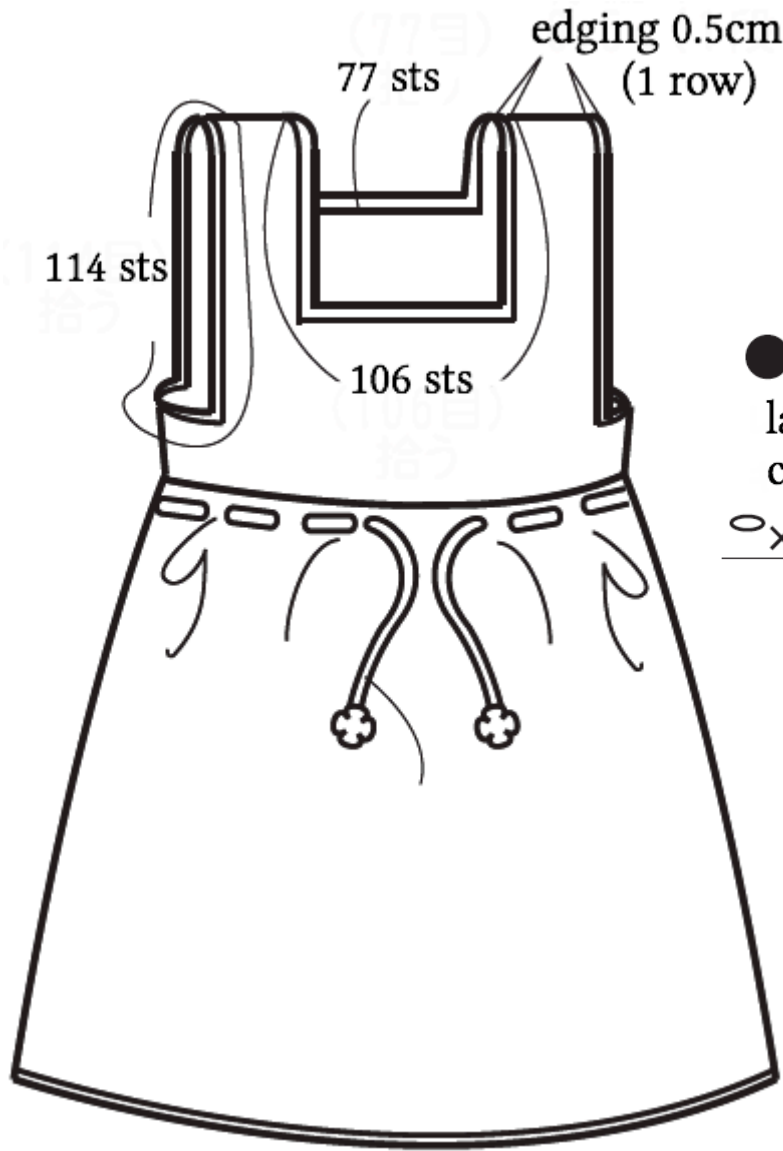

● edging

ladies': 2.5mm hook

child: 2.3mm hook

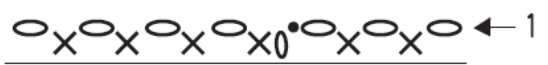

● drawstring

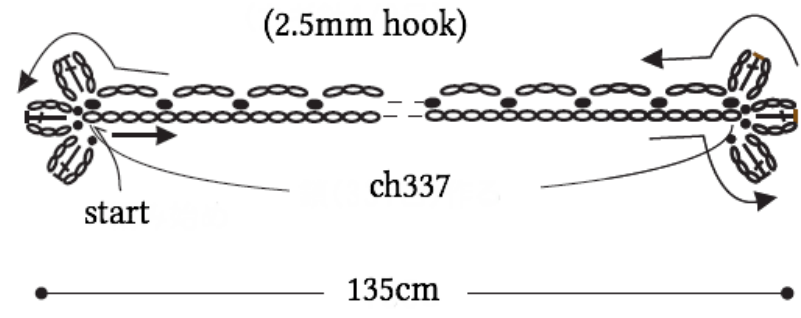

※ same for both sizes